



CALL FOR IMMEDIATE DELIVERY

708-369-3675 - **24 HOUR SERVICE**

888-998-VMED (8633)

# ValueMed



RENTAL EQUIPMENT



SUCTION



RESPIRATORY

**PLEASE CONTACT US 24/7 AT:**

EMAIL:

ValueMed.sales@gmail.com

WEBSITE:

www.valuemed.co

TOLL FREE:

888-998-VMED (8633)

FAX:

888-676-0711

# EQUIPMENT REPAIR

## EQUIPMENT REPAIR WHITE GLOVE SERVICE



FILL THE BASKET WITH BROKEN EQUIPMENT,  
GIVE US A CALL - WE WILL PICK UP,  
REPAIR & RETURN YOUR REPAIRS PROMPTLY

## \*\*BLENDER OVERHAULS\*\*

### Airvo 2 Repair



### Blenders



### OVERHAULS INCLUDE

- \*Ultrasonic Cleaning
- \*Replacement Of Necessary Parts
- \*Testing \*\*Full PM Kit
- \*Calibration To Manufacturers Specs

- \*BioMed Devices
- \*Tenacore
- \*Precision
- \*Sechrist

Overhauls are Recommended Every 2 Years

### Flowmeters



### Wyes



### Regulators



### MR-850



### Med Gas Outlets



### Suction Regulators-Flat Rate Repair



### Respirometers



# INDEX

## RESPIRATORY SUPPLIES & EQUIPMENT

Blenders.....	10
Couplers.....	8-9
Custom Hoses.....	12
Cylinder Carts.....	15
Flowmeters.....	4-6
High Pressure Regulators.....	16-20
Wyes.....	6
Oxygen Analyzers.....	11
Respirometers.....	7
Insufflator.....	21
IV Pole Accesories.....	23
Neonatal Care.....	7
NIF Gauges.....	14
Oxygen Sensors.....	13
Quick Connects.....	8-9
Rail Brackets.....	22

## RENTAL EQUIPMENT

Air/Oxygen Blender High Flow System.....	32
Draeger Evita Infinity V500.....	28
Fisher Paykel Airvo 2.....	31
Hill Rom Metaneb.....	33
Hill Rom The Vest Unit.....	33
LTV 1200 / MRI LTV 1200.....	27
Maquet Servo-I Ventilator.....	28
Max Venturi-High Flow.....	31
Philips EVO & EV 300 Ventilator.....	29
Philips Trilogy 202.....	29
Philips V60.....	26
Philips T-70 Cough Assist.....	34
Puritan Bennett 980 Ventilator.....	30
Puritan Bennett 840 Ventilator.....	30
Respironics Cough Assist.....	34
Respironics Vision.....	26
Vapotherm Precision Flow Plus.....	32

## EQUIPMENT REPAIR WHITE GLOVE SERVICE

FILL THE BASKET WITH  
BROKEN EQUIPMENT,  
GIVE US A CALL  
WE WILL PICK UP,  
REPAIR & RETURN YOUR  
REPAIRS PROMPTLY  
**888-998-8633**



## SUCTION REGULATORS

Amvex.....	36
Boehringer.....	37
Chemetron / Allied.....	38
Gentec.....	38
Ohio.....	36
Overflow Safety Trap.....	37
Precision Medical.....	38
Suction Canisters & Rings.....	39-40

## MEDICAL GAS OUTLETS

Ohio.....	42
Puritan Bennett.....	43
Chemetron.....	44
Hill Rom Horizon.....	45
Outlet Repair Kits.....	46-47
NPT Fittings.....	50-52

## PROFESSIONAL SERVICES

Equipment Repair.....	59
Medical Gas Verification.....	57
MRI Equipment & Design.....	58
Shutdown Services.....	54-56









**24 HOUR SERVICE**  
YOUR JUST IN TIME RENTAL SUPPLIER

www.valuemed.co  
888-998-8633  
ValueMed.sales@gmail.com

# FLOWMETERS

## SPECIALTY FLOWMETERS











MODEL						
	O2 NEB BLOCK 0-15 FLOWMETER 7-8,14-16,24-26	O2 ELIMINATOR 0-15LPM FLOWMETER	O2 FLOWMETER 0-26 LPM	O2 DIAL FLOWMETER 25,15,8 & 4 LPM	O2 NON-FERROUS .5 - 15 LPM	CO2 0-12LPM
DISS FEMALE 	1MFA6073 7-8LPM 1MFA6153 14-16LPM 1MFA6243 24-26LPM	1MFA7153 15LPM 1MFA7243 24LPM 1MFA7002 FLUSH	26-100	25-100-D 25 LPM 15-100-D 15LPM 8-100-D 8LPM 4-100-D 4LPM	NF-100	CO2-180
PURITAN BENNETT 	1MFA6078 7-8LPM 1MFA6158 14-16LPM 1MFA6248 24-26LPM	1MFA7158 15LPM 1MFA7248 24LPM 1MFA7008 FLUSH	26-201	25-201-D 25 LPM 15-201-D 15LPM 8-201-D 8LPM 4-201-D 4LPM	NF-201	CO2-280
CHEMETRON 	1MFA6076 7-8LPM 1MFA6156 14-16LPM 1MFA6246 24-26LPM	1MFA7156 15LPM 1MFA7246 24LPM 1MFA7006 FLUSH	26-401	25-401-D 25 LPM 15-401-D 15LPM 8-401-D 8LPM 4-401-D 4LPM	NF-401	CO2-480
OXEQUIP 	1MFA6077 7-8LPM 1MFA6157 14-16LPM 1MFA6247 24-26LPM	1MFA7157 15LPM 1MFA7247 24LPM 1MFA7007 FLUSH	26-301	25-301-D 25 LPM 15-301-D 15LPM 8-301-D 8LPM 4-301-D 4LPM	NF-301	N/A
MEDSTAR 	1MFA607M 7-8LPM 1MFA615M 14-16LPM 1MFA624M 24-26LPM	1MFA715M 15 LPM 1MFA724M 24LPM 1MFA700M FLUSH	26-302	25-302-D 25 LPM 15-302-D 15LPM 8-302-D 8LPM 4-302-D 4LPM	NF-302	CO2-355
OHMEDA 	1MFA6075 7-8LPM 1MFA6155 14-16 LPM 1MFA6245 24-26LPM	1MFA7155 15LPM 1MFA7245 24LPM 1MFA7005 FLUSH	26-501	25-501-D 25 LPM 15-501-D 15LPM 8-501-D 8LPM 4-501-D 4LPM	NF-501	CO2-580
1/8" NPT	1MFA6070 7-8LPM 1MFA6150 14-16LPM 1MFA6240 24-26LPM	1MFA7150 15LPM 1MFA7240 24LPM 1MFA7000 FLUSH	26-18NPT	18-25-22D 25LPM 18-15-22D 15LPM 18-8-22D 8LPM 18-4-22D 4LPM	18-NF	18-CO2





# FLOWMETERS

## SPECIALTY FLOWMETERS













MODEL	 OXYGEN / AIR FLOWMETER WYE	 OXYGEN / AIR FLOWMETER WYE WITH POWER TAKEOFF	 0-70 LPM O2	 COLUMN MOUNT- FLOWMETER O2
DISS FEMALE 	OXYGEN 22-15-102 AIR 22-15-112	OXYGEN 22-15-102PT AIR 22-15-112PT	O2- 75-100 AIR - 75-110	CM-100
PURITAN BENNETT 	OXYGEN 22-15-201 AIR 22-15-211	OXYGEN 22-15-201PT AIR 22-15-211PT	O2- 75-201 AIR- 75-210	CM-201
CHEMETRON 	OXYGEN 22-15-401 AIR 22-15-411	OXYGEN 22-15-401PT AIR 22-15-411PT	O2- 75-401 AIR-75-410	CM-401
OXEQUIP 	OXYGEN 22-15-301 AIR 22-15-311	OXYGEN 22-15-301PT AIR 22-15-311PT	O2- 75-301 AIR- 75-311	CM-301
MEDSTAR 	OXYGEN 22-15-302 AIR 22-15-312	OXYGEN 22-15-302PT AIR 22-15-312PT	O2- 75-302 AIR- 75-312	CM-302
OHMEDA 	OXYGEN 22-15-501 AIR 22-15-510	OXYGEN 22-15-501PT AIR 22-15-510PT	O2-75-501 AIR-75-510	CM-501
1/8" NPT	OXYGEN 22-102-18F AIR 22-112-18F	OXYGEN 22-102-18FPT AIR 22-112-18FPT	O2- 18-75-22 AIR-18-75-23	





**24 HOUR SERVICE**  
YOUR JUST IN TIME RENTAL SUPPLIER

www.valuemed.co  
888-998-8633  
ValueMed.sales@gmail.com

# FLOWMETERS & WYES

MODEL						
	0-15 LPM STANDARD O2 FLOWMETER	0-15 LPM W/ 50 PSI POWER TAKE OFF	0-15 LPM STANDARD AIR FLOWMETER	0-3 LPM PED/NEO OXYGEN *	0-1 LPM PED/NEO OXYGEN**	200 CC PED/NEO OXYGEN***
 OHIO	15-501	OXYGEN 15-501PT AIR 15-510PT	15-510	3-501	1-501	200-501
 PURITAN BENNETT	15-201	OXYGEN 15-201PT AIR 15-211PT	15-211	3-201	1-201	200-201
 CHEMETRON	15-401	OXYGEN 15-401PT AIR 15-411PT	15-411	3-401	1-401	200-401
 OXEQUIP	15-301	OXYGEN 15-301PT AIR 15-311PT	15-311	3-301	1-301	200-301
 MEDSTAR	15-302	OXYGEN 15-302PT AIR 15-312PT	15-312	3-302	1-302	200-302
 DISS	15-102	OXYGEN 15-102PT AIR 15-112PT	15-112	3-102	1-102	200-102

OHIO WYE ASSEMBLY	
	
22-501-500	OXYGEN
22-511-510	AIR
22-531-530	VACUUM

PURITAN BENNETT WYE ASSEMBLY	
	
22-201-200	OXYGEN
22-211-210	AIR
22-231-230	VACUUM

CHEMETRON WYE ASSEMBLY	
	
22-401-400	OXYGEN
22-411-410	AIR
22-431-430	VACUUM

MEDSTAR WYE ASSEMBLY	
	
22-302-300	OXYGEN
22-312-310	AIR
22-332-330	VACUUM



# RESPIROMETERS / ET CLAMPS



1 1/2"

**Small Wright Mark 8  
Respirometer 700-800**



2"

**Large Wright Mark 21  
Respirometer 700-021**



**Rubber Crash Guard**

700-401 Small Dial Cover

700-402 Large Dial Cover

**\*SMALL RESPIROMETERS COME WITH PROTECTIVE CRASH GUARD\***

## Precision Endotracheal Tube Anti Slippage Clamp

**\*Modified Precision Cord Clamp\***

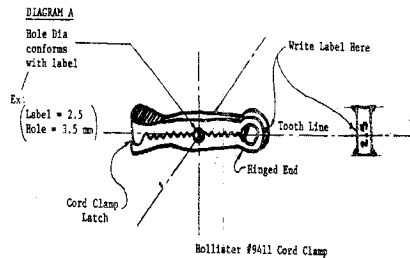

## 64ml Infant Test Lung



10 Pack

4-0050-64ML



## G5 NEOCUSSOR Neonatal Percussor Unit

Neonatal Percussor NC90

Replacement Applicators NAP-7PKG 25/Pack

Part ET-20	ET Tube Size 2.0 MM	\$3.99 Each
Part ET-25	ET Tube Size 2.5 MM	\$3.99 Each
Part ET-30	ET Tube Size 3.0 MM	\$3.99 Each
Part ET-35	ET Tube Size 3.5 MM	\$3.99 Each
Part ET-40	ET Tube Size 4.0 MM	\$3.99 Each
Part ET-45	ET Tube Size 4.5 MM	\$3.99 Each
Part M100	Clamp Only	\$1.25 Each

**\*CLAMP SOLD SEPARATE FOR MODIFIED CLAMP**



**24 HOUR SERVICE**

YOUR JUST IN TIME RENTAL SUPPLIER

[www.valuemed.co](http://www.valuemed.co)

888-998-8633

[ValueMed.sales@gmail.com](mailto:ValueMed.sales@gmail.com)

# QUICK CONNECTS AND COUPLERS

## CHEMETRON FEMALE COUPLERS

1/4" HOSE BARB	
	
CHEMETRON / NCG	
400-77	OXYGEN
410-77	AIR
430-77	VACUUM
420-77	N2O
450-77	WAGD
480-77	CO2

DISS MALE	
	
CHEMETRON / NCG	
400-55	OXYGEN
410-55	AIR
430-55	VACUUM
420-55	N2O
450-55	WAGD
480-55	CO2

DISS FEMALE	
	
CHEMETRON / NCG	
55-400	OXYGEN
55-410	AIR
55-430	VACUUM
55-420	N2O
55-450	WAGD
55-480	CO2

1/4" NPT MALE	
	
CHEMETRON / NCG	
400-14	OXYGEN
410-14	AIR
430-14	VACUUM
420-14	N2O
450-14	WAGD
480-14	CO2

## PURITAN BENNETT FEMALE COUPLERS

1/4" HOSE BARB	
	
Puritan Bennett	
200-77	OXYGEN
210-77	AIR
230-77	VACUUM
220-77	N2O
250-77	WAGD
280-77	CO2

DISS MALE	
	
Puritan Bennett	
200-55	OXYGEN
210-55	AIR
230-55	VACUUM
220-55	N2O
250-55	WAGD
280-55	CO2

DISS FEMALE	
	
Puritan Bennett	
55-200	OXYGEN
55-210	AIR
55-230	VACUUM
55-220	N2O
55-250	WAGD
55-280	CO2

1/4" NPT MALE	
	
Puritan Bennett	
200-14	OXYGEN
210-14	AIR
230-14	VACUUM
220-14	N2O
250-14	WAGD
280-14	CO2

## HOSE QUICK CONNECT ADAPTERS

DISS CHEMETRON	PART#	GAS
	401-55	O2
	411-55	AIR
	421-55	N2O
	431-55	VAC
	451-55	EVAC
	481-55	CO2

DISS MEDSTAR	PART#	GAS
	302-55	O2
	312-55	AIR
	322-55	N2O
	332-55	VAC
	354-55	EVAC
	355-55	CO2

DISS PURITAN BENNETT	PART#	GAS
	201-55	O2
	211-55	AIR
	221-55	N2O
	231-55	VAC
	251-55	EVAC
	281-55	CO2

DISS OHIO	PART#	GAS
	501-55	O2
	511-55	AIR
	521-55	N2O
	531-55	VAC
	551-55	EVAC
	581-55	CO2







# QUICK CONNECTS AND COUPLERS

## MEDSTAR FEMALE COUPLERS

1/4" HOSE BARB	
	
<b>MEDSTAR</b>	
300-77	OXYGEN
310-77	AIR
330-77	VACUUM
320-77	N2O
353-77	WAGD
	CO2

DISS MALE	
	
<b>MEDSTAR</b>	
300-55	OXYGEN
310-55	AIR
330-55	VACUUM
320-55	N2O
352-55	WAGD

DISS FEMALE	
	
<b>MEDSTAR</b>	
55-300	OXYGEN
55-310	AIR
55-330	VACUUM
55-320	N2O
55-352	WAGD

1/4" NPT MALE	
	
<b>MEDSTAR</b>	
300-14	OXYGEN
310-14	AIR
330-14	VACUUM
320-14	N2O
352-14	WAGD
	CO2

## OHIO FEMALE COUPLERS

1/4" HOSE BARB	
	
<b>OHIO</b>	
500-77	OXYGEN
510-77	AIR
530-77	VACUUM
520-77	N2O
550-77	WAGD
580-77	CO2

DISS MALE	
	
<b>OHIO</b>	
500-55	OXYGEN
510-55	AIR
530-55	VACUUM
520-55	N2O
550-55	WAGD
580-55	CO2

DISS FEMALE	
	
<b>OHIO</b>	
55-500	OXYGEN
55-510	AIR
55-530	VACUUM
55-520	N2O
55-550	WAGD
55-580	CO2

1/4" NPT MALE	
	
<b>OHIO</b>	
500-14	OXYGEN
510-14	AIR
530-14	VACUUM
520-14	N2O
550-14	WAGD
580-14	CO2

1/8" MALE NPT CHEMETRON		
		
PART #	GAS	PRICE
401-18	O2	
411-18	AIR	
421-18	N2O	
431-18	VAC	
451-18	EVAC	
481-18	CO2	

1/8" MALE NPT PURITAN BENNETT		
		
PART #	GAS	PRICE
201-18	O2	
211-18	AIR	
221-18	N2O	
231-18	VAC	
251-18	EVAC	
281-18	CO2	

1/8" MALE NPT MEDSTAR		
		
PART #	GAS	PRICE
302-18	O2	
312-18	AIR	
322-18	N2O	
332-18	VAC	
354-18	EVAC	
355-18	CO2	

1/8" MALE NPT OHIO		
		
PART #	GAS	PRICE
501-18	O2	
511-18	AIR	
521-18	N2O	
531-18	VAC	
551-18	EVAC	
581-18	CO2	



**24 HOUR SERVICE**  
YOUR JUST IN TIME RENTAL SUPPLIER

www.valuemed.co  
888-998-8633  
ValueMed.sales@gmail.com

# AIR / OXYGEN BLENDERS & ACCESSORIES

## BIOMED DEVICES



HI-FLOW BLENDER	BM-700-01
LOW-FLOW BLENDER	BM-700-03

## MAX-VENTURI WITH SENSOR



Sensor	MAX-250E
Max-Venturi	MV-S

## CUSTOM CONFIGURATIONS

Elbowed Flowmeters,  
Silencers, Brackets, Hoses



## 10 FOOT AIR / OXYGEN BLENDER HOSES



BM-208-007



BM-108-007

## GE VERTICAL RAIL BRACKET



BR-904-007

## BLENDER POLE MOUNT BRACKET



BR-800-007

## HIGH FLOW SILENCER

FITS 15, 22MM HOSE & FLOWMETERS  
219P50



DAMPENS NOISE  
AND MINIMIZES  
PATIENT  
STIMULATION

## MAXVENTURI MUFFLER



R211P38

## WATER TRAP



AFA116-2-9

## HILL ROM / FAIRFIELD BLENDER BRACKET



BR-901-007

## BLENDER ACCESSORIES

BM-108-007	10 FT Oxygen Hose, DISS Male x DISS Female
BM-208-007	10 FT Air Hose, DISS Female x DISS Female
BM-300-007	Elbowed 0-15 LPM Oxygen Flowmeter
BM-400-007	Elbowed 0-3 LPM Oxygen Flowmeter
BM-500-007	Elbowed 0-1 LPM Oxygen Flowmeter
BM-570-007	Elbowed 0-70 LPM Oxygen Flowmeter
BM-600-007	Elbowed 15 LPM Oxygen Flowmeter Wye
AFA11629	Air Inlet Filter / Water Trap
BM-260-007	Elbowed 26 LPM Oxygen Flowmeter
BM-200-007	Elbowed 200cc Oxygen Flowmeter

## ELBOWED FLOWMETER

BM-300-007

## WALL MOUNT BRACKET



BR-850-007

## VAC BRACKET TO BLENDER

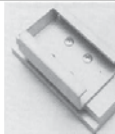

BR-903-007



# RESPIRATORY PRODUCTS

## OXYGEN MONITORS & ANALYZERS

**MiniOX O2 MONITOR  
3000 With HI-LO Alarm**



**814365**

Sensor	MAX 13
--------	--------

**O2 MONITOR With  
HI-LO Alarms**



**MAXO2ME**

Sensor	MAX-550E
--------	----------

**O2 ANALYZER With  
CABLE**



**MAXO2+AE**

Sensor	MAX-250E
--------	----------

**O2 ANALYZER  
Without CABLE**



**MAXO2+A**

Sensor	MAX-250+
--------	----------

**PERCUSSOR WITH  
10 ft OXYGEN HOSE**



**2500**

**HANDI+ O2  
SPOT CHECKER**



**R218P12**

Sensor	MAX-250
--------	---------

**BLENDER BUDDY**



AVAILABLE IN  
70, 30, 15, 3 LPM

Sensor	MAX-250+
--------	----------

**CUFFLATOR**



**54-04-000**

With Rubber Crash Guard

**POLE MOUNTED  
FLOWMETER &  
HOSE**



70 LPM	70-102-PM
15 LPM	15-102-PM

**AIRVO-2 UNIT**



**PT-101US**

**AIRVO-2 ROLLING  
STAND / TRAY**



STAND	900PT421
TRAY	900PT405

**ELBOWED OXYGEN /  
AIR BLENDER HOSES**



Full Custom Hoses-Any  
Length & Quick Connect

4 FT	BM-SET-4
6 FT	BM-SET-6
8 FT	BM-SET-8



**24 HOUR SERVICE**  
YOUR JUST IN TIME RENTAL SUPPLIER

[www.valuemed.co](http://www.valuemed.co)  
888-998-8633  
[ValueMed.sales@gmail.com](mailto:ValueMed.sales@gmail.com)

# BUILT TO ORDER HOSES

## HIGH PRESSURE HOSES-BY THE FOOT / CUSTOM CONFIGURATIONS



\* Available in custom lengths and configurations

\* Available in a variety of gasses

\*Sold by The Foot **\*Built to your needs**

\*200 PSI Max

### TUBING NIPPLE



GREEN	132EMG	100/ PK
YELLOW	0137	50/PK

## STANDARD 10 FOOT DISS FEMALE x DISS FEMALE HOSES

### 10 FT CONDUCTIVE FOR ANESTHESIA

#100-10-22-100	Green	Oxygen
#110-10-23-110	Yellow	Air
#120-10-24-120	Blue	Nitrous Oxide
130-10-25-130	White	Vacuum
#140-10-26-140	Black	Nitrogen
150-10-27-150	Lavender	EVAC
180-10-28-180	Gray	Carbon Dioxide

### 10 FT NON CONDUCTIVE RESPIRATORY

100-10-20-100	Green	Oxygen
110-10-21-110	Yellow	Air



## HOSE QUICK CONNECT ADAPTERS

### DISS CHEMETRON



PART#	GAS
401-55	O2
411-55	AIR
421-55	N2O
431-55	VAC
451-55	EVAC
481-55	CO2

### DISS MEDSTAR



PART#	GAS
302-55	O2
312-55	AIR
322-55	N2O
332-55	VAC
354-55	EVAC
355-55	CO2

### DISS PURITAN BENNETT



PART#	GAS
201-55	O2
211-55	AIR
221-55	N2O
231-55	VAC
251-55	EVAC
281-55	CO2

### DISS OHIO



















PART#	GAS
501-55	O2
511-55	AIR
521-55	N2O
531-55	VAC
551-55	EVAC
581-55	CO2





# OXYGEN SENSORS

## REPLACEMENT OXYGEN SENSORS

<p><b>MAX-125M</b></p>  <p>12 Month Warranty  <b>Replacement For:</b>            MAX-16</p>	<p><b>MAX-250</b></p>  <p>12 Month Warranty  <b>Replacement For:</b>            VapoTherm            Precision flow</p>	<p><b>MAX-13</b></p>  <p>14 Month Warranty  <b>Replacement For:</b>            MiniOX I, II, III, 3000            Teledyne R-17            PB 4-020933-00            Esprit Ventilator</p>	<p><b>MAX-13-250</b></p>  <p>24 Month Warranty  <b>Replacement For:</b>            MiniOx I</p>										
<p><b>MAX-16</b></p>  <p>16 Month Warranty  <b>Replacement For:</b>            PB 840/980 SERIES            4-072214-00</p>	<p><b>MAX-12</b></p>  <p>12 Month Warranty  <b>Replacement For:</b>            Siemens 900C, 300            Teledyne R-22, R24            Avea Ventilator</p>	<p><b>MAX-12A</b></p>  <p>14 Month Warranty  <b>Replacement For:</b>            Hillrom Isolette            Incubator            Viasys Avea Ventilator</p>	<p><b>MAX-9</b></p>  <p>12 Month Warranty  <b>Replacement For:</b>            Hudson 5500</p>										
<p><b>MAX-1</b></p>  <p>12 Month Warranty  <b>Replacement For:</b>            GE/Ohmeda 4760 Oxicap            5250RGM            5120 O2 Monitor</p>	<p><b>MAX-2</b></p>  <p>24 Month Warranty  <b>Replacement For:</b>            Draeger Anesthesia</p>	<p><b>MAX-11</b></p>  <p>12 Month Warranty  <b>Replacement For:</b>            N.A. Draeger            Draeger-Narkomed            Babylog, Evita Ventilator</p>	<p><b>MAX-12C</b></p>  <p>14 Month Warranty  <b>Replacement For:</b>            Viasys, Avea            Ventilators</p>										
<p><b>MAX-11i</b></p>  <p>12 Month Warranty  <b>Replacement For:</b>            Draeger Incubators            IC 8000            High Temp Applications</p>	<p><b>MAX-43</b></p>  <p>12 Month Warranty  <b>Replacement For:</b>            GE (Datex Ohmeda)            Giraffe</p>	<p><b>MAX-17</b></p>  <p><b>Replacement For:</b>            Teledyne            60T, 191T &amp; 200T</p>	<p><b>MAX-250K</b></p>  <table border="1"> <tbody> <tr> <td>DC</td> <td>Panduit</td> </tr> <tr> <td colspan="2"><b>Replacement For:</b></td> </tr> <tr> <td colspan="2">Viasys, Vela, Ventilators</td> </tr> <tr> <td>DC Adapter</td> <td>250K-001</td> </tr> <tr> <td>Panduit</td> <td>250K-009</td> </tr> </tbody> </table>	DC	Panduit	<b>Replacement For:</b>		Viasys, Vela, Ventilators		DC Adapter	250K-001	Panduit	250K-009
DC	Panduit												
<b>Replacement For:</b>													
Viasys, Vela, Ventilators													
DC Adapter	250K-001												
Panduit	250K-009												





**24 HOUR SERVICE**  
 YOUR JUST IN TIME RENTAL SUPPLIER

www.valuemed.co  
 888-998-8633  
 ValueMed.sales@gmail.com

# PRESSURE AND VACUUM GAUGES

## NIF GAUGES / VACUUM PRESSURE GAUGES

	<b>00-310</b>	<b>\$389.00</b>	Manometer with Adjustable Pop-Off 2.5" to 3.5" Clamp	
	<b>00-300</b>	<b>\$329.00</b>	Manometer with Adjustable Pop-Off 0.75" to 1.75" Clamp	
	<b>00-274</b>	<b>\$115.00</b>	Manometer with Adjustable Pop-Off	
	<b>00-199</b>	<b>\$79.00</b>	Replacement Gauge with 0.25" NPT	
	<b>274-Max</b>	<b>\$159.00</b>	Manometer with Pop-Off with MAX Hand	
	<b>00-273</b>	<b>\$69.00</b>	Pressure Relief Valve	
	<b>00-195</b>	<b>\$89.00</b>	Wall Mount Bracket for 00-199	
<b>**ALL 2.5" DIAMETER GAUGES**</b>				
<b>**HEAVY DUTY METAL CASE**</b>				
<b>00-300</b>			<b>00-274</b>	



± 30 cm/H2O  
1/8" Tubing Nipple  
30-PBS W/O Recorder  
30-PBR W/Recorder



± 60 cm/H2O  
1/8" Tubing Nipple  
60-PBS W/O Recorder  
60-PBR W/Recorder



-40 +80 cmH2O  
1/4" NPT Bottom Port  
60-TBS W/O Recorder  
60-TBR W/Recorder



± 60 cm/H2O  
1/4" NPT Back Port  
60-TRS W/O Recorder  
60-TRR W/Recorder

**MANOMETER with POP OFF**





**00-274 STANDARD**  
**274-MAX Max Hand**

**GE VERTICAL RAIL BRACKET / GAUGE**



**GE1072**

**POLE MOUNT NIF GAUGE CLAMP**

3/4 to 1 1/2 Inch	1 to 2 1/2 Inch
SMALL CLAMP	LARGE CLAMP
<b>BE-148-5-2</b>	<b>BE-148-2-2.5</b>



**GAUGE COVER**

**00-150**

Helps Prevent Damage



# CYLINDER CARTS AND STANDS

## CYLINDER CARTS & STANDS

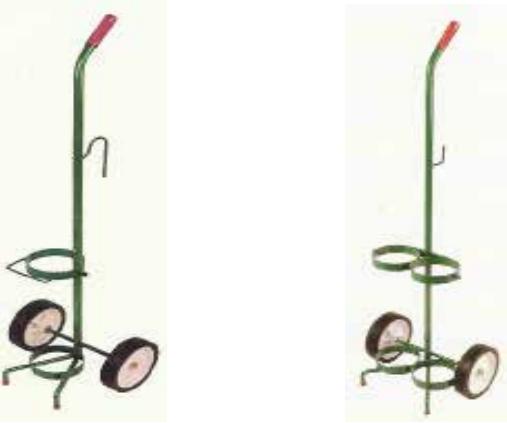

D & E Size Carts		
		
PART#	DESCRIPTION	
B-6105	Standard	
B-6105-2U	Standard, Box of 2	
B-6C105	Chrome	
MRI-1AA	Non-Magnetic	
B-6205	Dual Cylinder	

H Cylinder Carts (Single)	
	
PART#	DESCRIPTION
B-6114	Standard
MRI B-6108	Non-Magnetic

H Cylinder Carts (Dual)	
	
PART#	DESCRIPTION
B-6214	Standard

D & E Cylinder Stands		
PART#	DESCRIPTION	CAPACITY
B-6040	Cylinder Capacity:	4
B-6060	Cylinder Capacity:	6
B-6120	Cylinder Capacity:	12
B-6180	Cylinder Capacity:	18
B-6240	Cylinder Capacity:	24



2 WHEEL	Multiple D & E Carts & Stands			4 WHEEL
	<b>2 Wheel</b>			
	B-6041	Cylinder Capacity:	4	
	B-6061	Cylinder Capacity:	6	
	B-6121	Cylinder Capacity:	12	
	<b>4 Wheel</b>			
	B-6064	Cylinder Capacity:	6	
	B-6124	Cylinder Capacity:	12	
	B-6184	Cylinder Capacity:	18	
	B-6246	Cylinder Capacity:	24	





**24 HOUR SERVICE**  
YOUR JUST IN TIME RENTAL SUPPLIER

www.valuemed.co  
888-998-8633  
ValueMed.sales@gmail.com

# MEDICAL GAS REGULATORS

## OXYGEN \* MEDICAL AIR \* NITROUS OXIDE HIGH PRESSURE REGULATORS

50 PSI PRESET REGULATORS		
		
<b>OXYGEN</b>		
<b>50-870</b>	Small Cylinder Yoke	870 CGA
<b>50-540</b>	Large Cylinder Nut	540 CGA
<b>AIR</b>		
<b>50-950-08</b>	Small Cylinder Yoke	950 CGA
<b>50-346-08</b>	Large Cylinder Nut	346 CGA
<b>NITROUS OXIDE</b>		
<b>50-910</b>	Small Cylinder Yoke	910 CGA
<b>50-326</b>	Large Cylinder Nut	326 CGA

0-100 PSI ADJUSTABLE REGULATORS		
		
<b>OXYGEN</b>		
<b>100-870</b>	Small Cylinder Yoke	870 CGA
<b>100-540</b>	Large Cylinder Nut	540 CGA
<b>AIR</b>		
<b>100-950</b>	Small Cylinder Yoke	950 CGA
<b>100-346</b>	Large Cylinder Nut	346 CGA
<b>NITROUS OXIDE</b>		
<b>100-910</b>	Small Cylinder Yoke	910 CGA
<b>100-326</b>	Large Cylinder Nut	326 CGA

## HELIUM / HELI-OX HIGH PRESSURE REGULATORS

0-100 PSI ADJUSTABLE		
		
<b>100% HELIUM</b>		
100-930	Small Cylinder Yoke	930 CGA
100-580	Large Cylinder Nut	580 CGA
<b>HELIUM &lt;80%</b>		
100-890	Small Cylinder Yoke	880 CGA
100-280	Large Cylinder Nut	280 CGA
<b>HELIUM &gt; 80%</b>		
<b>100-930</b>	<b>Small Cylinder Yoke</b>	<b>930 CGA</b>
<b>100-500</b>	<b>Large Cylinder Nut</b>	<b>500 CGA</b>

<b>REPLACEMENT</b>
0-16 LPM HELI-OX FLOWMETER
<b>Part # 65-HE</b>

50 PSI PRESET		
		
<b>100% HELIUM</b>		
50-930-65	Small Cylinder Yoke	930 CGA
50-580-65	Large Cylinder Nut	580 CGA
<b>HELIUM &lt;80%</b>		
50-890-65	Small Cylinder Yoke	880 CGA
50-280-65	Large Cylinder Nut	280 CGA
<b>HELIUM &gt; 80%</b>		
50-930-65	Small Cylinder Yoke	930 CGA
50-500-65	Large Cylinder Nut	500 CGA







# MEDICAL GAS REGULATORS

## "E" & "H" TANK

### 50 PSI PRESET REGULATORS PURITAN BENNETT / CHEMETRON

50 PSI PRESET MODEL WITH PB FEMALE			
			
50-870-200	"E" Tank, O2	870 CGA	Yoke
50-540-200	"H" Tank, O2	540 CGA	Nut
50-950-210	"E" Tank, Air	950 CGA	Yoke
50-346-210	"H" Tank, Air	346 CGA	Nut
50-910-220	"E" Tank, N2O	950 CGA	Yoke
50-236-220	"H" Tank, N2O	346 CGA	Nut

50 PSI PRESET MODEL WITH CHEMETRON FEMALE			
			
50-870-400	"E" Tank, O2	870 CGA	Yoke
50-540-400	"H" Tank, O2	540 CGA	Nut
50-950-410	"E" Tank, Air	950 CGA	Yoke
50-346-410	"H" Tank, Air	346 CGA	Nut
50-910-420	"E" Tank, N2O	950 CGA	Yoke
50-236-420	"H" Tank, N2O	346 CGA	Nut

## "E" & "H" TANK

### 50 PSI PRESET REGULATORS OHIO / MEDSTAR

50 PSI PRESET MODEL WITH OHIO FEMALE			
			
50-870-500	"E" Tank, O2	870 CGA	Yoke
50-540-500	"H" Tank, O2	540 CGA	Nut
50-950-510	"E" Tank, Air	950 CGA	Yoke
50-346-510	"H" Tank, Air	346 CGA	Nut
50-910-520	"E" Tank, N2O	950 CGA	Yoke
50-236-520	"H" Tank, N2O	346 CGA	Nut

50 PSI PRESET MODEL WITH MEDSTAR FEMALE			
			
50-870-300	"E" Tank, O2	870 CGA	Yoke
50-540-300	"H" Tank, O2	540 CGA	Nut
50-950-310	"E" Tank, Air	950 CGA	Yoke
50-346-310	"H" Tank, Air	346 CGA	Nut
50-910-320	"E" Tank, N2O	950 CGA	Yoke
50-236-320	"H" Tank, N2O	346 CGA	Nut





**24 HOUR SERVICE**  
YOUR JUST IN TIME RENTAL SUPPLIER



www.valuemed.co  
888-998-8633  
ValueMed.sales@gmail.com



# NITROGEN FITTINGS

## NITROGEN ACCESSORIES

	NITROGEN HOSE ASSEMBLIES		
	<b>611-20-26-610</b>	20 FT Nitrogen Hose	Schrader Male x Schrader Female
	<b>140-20-26-610</b>	20 FT Nitrogen Hose	DISS Nitrogen x Schrader Female
<b>140-20-26-140</b>	20 FT Nitrogen Hose	DISS Nitrogen x DISS Nitrogen	

	<b>NITROGEN FLEXIBLE CONVERTER HOSE</b>	<b>Schrader Elbow Quick Connect</b>	
	Air for Nitrogen to DISS Quick Connect		
	<b>55-1-610</b>		

DISS WYE	NITROGEN WYE ASSEMBLIES		SCHRADER WYE
	DISS Female x DISS Male	<b>140-142-142</b>	
	DISS Female x Schrader Female	<b>140-610-610</b>	
	Schrader Male x Schrader Female	<b>612-610-610</b>	
	Schrader Male x DISS Male	<b>612-142-142</b>	

SCHRADER MALE QUICK CONNECT	
Air / Nitrogen 1/8" NPT	
	
Swivel Style Quick Connect N2	<b>611-18</b>
Non Swivel Quick Connect N2	<b>612-18</b>

SCHRADER FEMALE COUPLER AIR FOR NITROGEN 1/4" NPT	
	<b>Part # 610-14</b>

DISS Female Nitrogen 1/4" NPT		
Hand Tight	<b>140-14</b>	
Hex Nut	<b>141-14</b>	

DISS MALE NITROGEN 1/4" NPT		
	DISS Male with Check	<b>142-14-CV</b>
	DISS Male without Check	<b>142-14</b>



BLACK NITROGEN 2 PIECE KIT	
	
<b>**For Nitrogen Only**</b>	<b>640-641-2</b>

BLACK SCHRADER NITROGEN WYE		
	DISS Inlet	<b>22-640-140</b>
	Schrader Inlet	<b>22-641-641</b>



# NITROGEN REGULATORS

## HIGH PRESSURE NITROGEN REGULATORS

								
Adjustable, 0-200 PSI, Diaphragm			Adjustable, 0-200 PSI, Diaphragm			Adjustable, 0-200 PSI, Diaphragm		
<b>2" Gauges with DISS Outlet</b>			<b>2" Gauges &amp; Schrader Female</b>			<b>2" Gauge, Schrader Coupler &amp; DISS</b>		
<b>200-960-142</b>	Small Cylinder E Yoke	960 CGA	<b>200-960-610</b>	Small Cylinder E Yoke	960 CGA	<b>200-960-610-142</b>	Small E Cylinder Yoke	960 CGA
<b>200-580-142</b>	Large Cylinder Nut	580 CGA	<b>200-580-610</b>	Large Cylinder Nut	580 CGA	<b>200-580-610-142</b>	Large Cylinder Nut	580 CGA

## EQUIPMENT REPAIR SERVICES FOR MED GAS ITEMS



### EQUIPMENT REPAIR - WHITE GLOVE SERVICE -

FILL THE BASKET WITH BROKEN EQUIPMENT,  
GIVE US A CALL - WE WILL PICK UP,  
REPAIR & RETURN YOUR REPAIRS PROMPTLY

**888-998-8633**

### Medical Gas Regulators & Flow Meters



Oxygen  
Medical Air  
Heli-Ox



Carbon Dioxide  
Nitrogen  
Nitrous Oxide

### Air / Oxygen Blenders

Overhauls  
Water Traps  
Hoses  
Brackets



### Bird - Bio Med Devices - Precision Medical *Recommended Overhaul every 2 years*

Cufflators



Respirometers



Percussors



**24 HOUR SERVICE**  
YOUR JUST IN TIME RENTAL SUPPLIER

www.valuemed.co  
888-998-8633  
ValueMed.sales@gmail.com

# CARBON DIOXIDE REGULATORS

## CARBON DIOXIDE HIGH PRESSURE REGULATORS

CARBON DIOXIDE REGULATORS WITH FLOWMETERS		
<b>100% CARBON DIOXIDE</b>		
<b>0-12 LPM Flowmeter</b>		
50-940-18 Small Cylinder Yoke	940 CGA	
50-320-18 Large Cylinder Nut	320 CGA	
<b>CARBON DIOXIDE &gt; 7% &amp; OXYGEN</b>		
<b>0-12 LPM Flowmeter</b>		
50-940-18 Small Cylinder Yoke	940 CGA	
50-500-18 Large Cylinder Nut	500 CGA	
<b>CARBON DIOXIDE &lt; 7% &amp; OXYGEN</b>		
<b>0-12 LPM Flowmeter</b>		
50-880-18 Small Cylinder Yoke	880 CGA	
50-280-18 Large Cylinder Nut	380 CGA	



Replacement CO2  
Flowmeter 0-12LPM



Starts at 1/2 Liter  
Part # 18-CO2

50 PSI PRESET CARBON DIOXIDE REGULATORS		
		
<b>100% CARBON DIOXIDE</b>		
50-940 Small Cylinder Yoke	940 CGA	
50-320 Large Cylinder Nut	320 CGA	
<b>CARBON DIOXIDE &lt;7% &amp; OXYGEN</b>		
50-880 Small Cylinder Yoke	880 CGA	
50-280 Large Cylinder Nut	380 CGA	
<b>CARBON DIOXIDE &gt; 7% &amp; OXYGEN</b>		
50-940 Small Cylinder Yoke	940 CGA	
50-500 Large Cylinder Nut	500 CGA	





ADJUSTABLE CARBON DIOXIDE REGULATORS		
<b>ADJUSTABLE 0-100 PSI</b>		<b>ADJUSTABLE 0-30 PSI With Tubing Nipple Clinical Instrumentation</b>
		
<b>100% CARBON DIOXIDE</b>		<b>100% CARBON DIOXIDE</b>
100-940 Small Cylinder Yoke	940 CGA	30-940 Small Cylinder Yoke
100-320 Large Cylinder Nut	320 CGA	30-320 Large Cylinder Nut
<b>CARBON DIOXIDE &lt; 7% &amp; OXYGEN</b>		<b>CARBON DIOXIDE &lt;7% &amp; OXYGEN</b>
100-880 Small Cylinder Yoke	880 CGA	30-880 Small Cylinder Yoke
100-280 Large Cylinder Nut	380 CGA	30-280 Large Cylinder Nut
<b>CARBON DIOXIDE &gt; 7% &amp; OXYGEN</b>		<b>CARBON DIOXIDE &gt; 7% &amp; OXYGEN</b>
100-940 Small Cylinder Yoke	940 CGA	30-940 Small Cylinder Yoke
100-500 Large Cylinder Nut	500 CGA	30-500 Large Cylinder Nut







# REGULATOR PARTS / MANIFOLDS / PIGTAIL

## INSUFFLATOR

DISS x DISS Female	Insufflator Yoke	Male Connector	Insufflator High Pressure Hose	High Pressure Hose 2 Tank Hook-Up 3000 psi Max With 2 Contents Gauges
5Ft CO2 200 PSI			3000 PSI 	
				
<b>180-5-28-180</b>	<b>94-06</b>	<b>19-276</b>	<b>716-3-716</b>	<b>G2-716-31-03</b>

E TANK YOKE		
		
PART#	GAS	CGA
870-14	Oxygen	870
880-14	CO2-O2	880
910-14	N2O	910
940-14	CO2	940
950-14	AIR	950
960-14	N2	960
973-14	GAS MIX	973
930-14	HELI-OX	930
890-14	GAS MIX	890

H-TANK HEX NUT AND NIPPLE		
		
PART#	GAS	CGA
280-14	HELI-OX	280
236-14	N2O	236
346-14	AIR	346
500-14	GAS MIX	500
540-14	OXYGEN	540
580-14	N2 & HELI	580
320-14	CO2	320

FLEXIBLE STAINLESS STEEL PIGTAILS					
* OXYGEN * MEDICAL AIR * NITROUS OXIDE * NITROGEN * CARBON DIOXIDE *					
FOR MANIFOLD REPLACEMENT Flexible Stainless Steel Pigtail			MULTIPLE CYLINDER TANK HOOKUP		
					
<b>3000 PSIG</b>			<b>3000 PSIGM</b>		
30" Long with One Way Check Valve			Custom Configurations Available Upon Request		
<b>326-32-326</b>	CGA 326	Nitrous Oxide	<b>T326-30-326</b>	CGA 326	Nitrous Oxide
<b>346-32-346</b>	CGA 346	Medical Air	<b>T346-30-346</b>	CGA 346	Medical Air
<b>580-32-580</b>	CGA 580	Nitrogen	<b>T580-30-580</b>	CGA 580	Nitrogen
<b>540-31-540</b>	CGA 540	Oxygen (Copper Only)	<b>T540-31-540</b>	CGA 540	Oxygen (Copper Only)
<b>320-32-320</b>	CGA 320	Carbon Dioxide	<b>T320-30-320</b>	CGA 320	Carbon Dioxide

V60 TRANSPORT OXYGEN MANIFOLD

<b>RM-505</b>



**24 HOUR SERVICE**  
YOUR JUST IN TIME RENTAL SUPPLIER

www.valuemed.co  
888-998-8633  
ValueMed.sales@gmail.com

# IV POLES & ACCESSORIES

**Pole Mounted Handle**



**P-3302-BLK**

**Dual Cylinder Holder**



**#1044-1**

**Single Cylinder Holder**



**#1046**

**Bag Hook**



**#1047**

**WATER BAG POLES FOR HEATER**

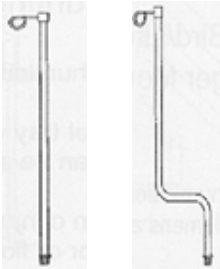

900MR012	Water Bag Pole 40"
900MR290	Water Bag Pole, Bent 28"

**HEATER BRACKET WITH BAG HOLE**

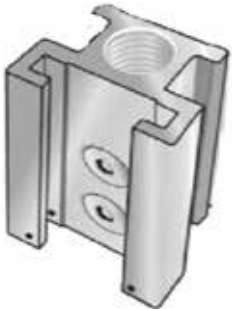

**FP-900-MR-087**

**POLE MOUNT CYLINDER HOLDER**



**PED-3601**

**POLE MOUNT BASKET**



**650-PM**

**Heavy Duty Space Saving Stackable & Adjustable IV Pole**



**RR-IVP-4**

**Ventilator / BiPap Support Arm**



**116-56**

**Support Arm Rail Bracket**



Use With Vision V-60

**RB-002**

**STACKABLE EQUIPMENT POLE**



**RR-IVP-0**

**HOSPITAL BED END CYLINDER HOLDER**



**BT-9TC**



# MODULAR SERVICES RAIL BRACKETS

<b>VERTICAL TRACK ADAPTER</b>	
	
<b>1000-511</b>	

<b>HORIZONTAL CHANNEL ADAPTER</b>	
	
<b>1109-511</b>	

<b>HORIZONTAL BRACKET</b>	
	
2704-520	<b>BLENDER</b>
2703-520	<b>VACUUM</b>

<b>VERTICAL BRACKET</b>	
	
2706-520	<b>BLENDER</b>
2701-520	<b>VACUUM</b>

<b>EQUIPMENT POST VERTICAL OR HORIZONTAL RAIL</b>	
	
6 IN POST	<b>2001-516</b>
10 IN POST	<b>2004-516</b>

<b>VERTICAL I.V. TREE</b>	
	
<b>2010-516</b>	

<b>RAIL MOUNT BASKET</b>	
	
HSI	<b>1460-513</b>
MODULAR SERVICES	<b>1454-513</b>

**\*Most Hospital Systems and Modular Services brackets are Universal\***

**\* LET VALUEMED HELP WITH YOUR PATIENT ROOM AND HEADWALL ORGANIZATION\***



<b>FISHER PAYKEL HEATER POLE MOUNT BRACKET</b>	
	

<b>WALL MOUNT BLENDER / SUCTION SLIDE BRACKET</b>	
	
<b>BR-850-007</b>	

<b>RAPID MOUNT HORIZONTAL SLIDE BRACKET FOR HORIZONTAL FEMALE RAILS</b>	
	
<b>BLENDER SLIDE</b>	<b>VACUUM SLIDE</b>
<b>BR-613601</b>	<b>BR-613600</b>

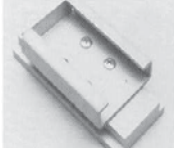
<b>VAC BRACKET TO BLENDER SLIDE</b>	
	
<b>BR-903-007</b>	

<b>HILL ROM / FAIRFIELD RAIL BRACKET</b>	
	
BR-901-007	<b>BLENDER</b>
BR-902-007	<b>VACUUM</b>



**24 HOUR SERVICE**  
YOUR JUST IN TIME RENTAL SUPPLIER

[www.valuemed.co](http://www.valuemed.co)  
888-998-8633  
[ValueMed.sales@gmail.com](mailto:ValueMed.sales@gmail.com)

# SPECIALTY HOSES

## HIGH PRESSURE HOSE



DISS FEMALE x DISS FEMALE, 10 FT LONG

100-10-100

Oxygen

110-10-110

Air

## AIR HOSE CRIMPER

CR-100



## RESPIRATORY SPACE SAVER



FLOWMETER WITH 10 FT. HOSE

OHIO

T15-501

PB

T15-201

MEDSTAR

T15-302

CHEMETRON

T15-401

DISS

T15-100

## AIR GUN WITH COILED HOSE



OUTLET CONNECTION

Ohio Medical Air

511-40

Chemetron Medical Air

411-40

Puritan Bennett Medical Air

211-40

DISS Medical Air

112-40

DISS Instrument Air

277-40

DISS Nitrogen

140-40

## SINGLE HOSE 15 FOOT LENGTH

Oxygen

100-015-100

Air

110-A15-110



## 1/4" HOSE BARB CHEMETRON



PART #	GAS	PRICE
401-77	O2	
411-77	AIR	
421-77	N2O	
431-77	VAC	
451-77	EVAC	
481-77	CO2	

## 1/4" HOSE BARB PB



PART #	GAS	PRICE
201-77	O2	
211-77	AIR	
221-77	N2O	
231-77	VAC	
251-77	EVAC	
281-77	CO2	

## 1/4" HOSE BARB MEDSTAR



PART #	GAS	PRICE
302-77	O2	
312-77	AIR	
322-77	N2O	
332-77	VAC	
354-77	EVAC	
355-77	CO2	

## 1/4" HOSE BARB OHIO



PART #	GAS	PRICE
501-77	O2	
511-77	AIR	
521-77	N2O	
531-77	VAC	
551-77	EVAC	
581-77	CO2	





# RESPIRATORY EQUIPMENT RENTALS

**24 HOUR SERVICE**

ValueMed.Sales@gmail.com

www.valuemed.co

888-998-8633



# ValueMed

## YOUR JUST IN TIME RENTAL SUPPLIER



**CALL FOR IMMEDIATE DELIVERY**

888-998-8633

Valuemed.co

VOL.2022-23

# BiPAP

## PHILIPS V-60 VENTILATOR & V60 PLUS HFT

FOR USE WITH	PART NUMBER	DESCRIPTION
 <p><b>V-60 VENTILATOR</b></p>	RENTAL-RM-801	Fisher Paykel Heater and Cable/Probe
	RENTAL-RM-505	Transport Oxygen Manifold
	V-60-6F	5 Pack of Inlet Filters
	RB-002	Support Arm Rail Bracket
	116-56	Support Arm
	1072621	Small Headgear Mask-AF531
	1072622	Medium Headgear Mask-AF531
	1072623	Large Headgear Mask-AF531
	1065832	Standard Single Limb Circuit
	1135739	Heated Single Limb Circuit
<p>The Philips RespiroNICE V60 Ventilator is an assist ventilator that is intended to augment patient breathing. It is intended for spontaneously breathing individuals who require mechanical ventilation.</p> <p><b>V60 AVAILABLE WITH HIGH FLOW THERAPY CAPABILITY</b>                      *Allows clinician to switch between NIV and HFT as patient condition changes</p>		





**\*HEATER & CABLES AVAILABLE\***





RESPIRONICS BiPAP VISION		
FOR USE WITH	PART NUMBER	DESCRIPTION
<p><b>BiPAP VISION</b></p>	RENTAL-RM-801	Fisher Paykel Heater and Cable / Probe
	VIS-6F	Replacement Inlet Filter 6/pack
	RB-002	Support Arm Rail Bracket
	116-56	Support Arm
<p>The BiPAP Vision System offers a form of sub-acute therapy for patients and may eliminate the need for intubation in appropriate candidates. The integrated display screen uses easy-to-read real time graphics in waveforms or bar scale format to provide enhanced monitoring for caregivers. Auto-Trak Sensitivity ensures optimum sensitivity despite changing breathing patterns or circuit leaks.</p>		



# VENTILATORS

	<b>LTV 1200 &amp;</b> <b>**MRI LTV TRANSPORT VENTILATOR**</b>		
	<b>FOR USE WITH</b>	<b>PART NUMBER</b>	
	<b>LTV 1200</b>	<b>RENTAL-RM-801</b>	Fisher Paykel Heater With Cable/Probe
		<b>29657-001</b>	Disposable Adult Circuit Without PEEP
		<b>29665-001</b>	15 Foot MRI Circuit Without PEEP
<b>LTV-DT-PM</b>		Pole Mount Bracket for LTV Ventilator	
<p>The small, lightweight Vyaire LTV 1200 Ventilator provides sophisticated critical care ventilation in austere environments. The LTV Ventilator supports both invasive and noninvasive applications. It combines portability, impact-resistant construction, easy-to-read displays, and comprehensive monitoring. A single solution for any patient weighing <b>5 kg or more</b></p>			
<p style="text-align: center;"><b>SPRINT BATTERY PACK INCLUDED</b></p> <p style="text-align: center;">*Approx 5 hours battery backup run time*</p>		 <p style="text-align: center;"><b>LTV POLE MOUNT BRACKET</b></p>	

	<b>*HEATER &amp; CABLES AVAILABLE*</b>	
	<b>FISHER PAYKEL MR850 HEATER AND CABLES</b>	
	<b>FOR USE WITH</b>	<b>PART NUMBER</b>
	<b>MR-850</b>	<b>RENTAL-RM-801</b>
<b>RT202</b>		Circuit & Chamber Kit
<b>MR-850</b>	<b>BR-825-007</b>	Pole Mount Bracket
	<p>One device supports multiple therapies for adult, pediatric and neonatal patients. Effective. One touch therapy selection combined with dual temperature feedback systems ensure ease of use. The MR850 uses flow sensor technology to automatically standby during periods of gas flow interruption. The MR-850 uses automatic algorithms for condensation control and humidity compensation.</p>	
	<b>FISHER PAYKEL REPLACEMENT CABLES</b>	
	<b>900MR869</b>	Temperature Probe-Blue
	<b>900MR805</b>	Heated Wire Adapter-Yellow



**24 HOUR SERVICE**  
 YOUR JUST IN TIME RENTAL SUPPLIER

www.valuemed.co  
 888-998-8633  
 ValueMed.sales@gmail.com

# VENTILATORS

## MAQUET SERVO-I VENTILATOR

FOR USE WITH	PART NUMBER	DESCRIPTION
SERVO-I	<b>RENTAL-RM-801</b>	Fisher Paykel Heater With Cable/Probe
SERVO-I	<b>64-87-180</b>	Servo I - Replacement Battery
SERVO-I	<b>6696947</b>	Servo I Expiratory Cassette



The Servo – I ventilator is a flexible ventilation platform and is available for both infants and adults. These configurations for the Servo-I are equipped with a number of ventilation modes that are suitable for each patient category. Ventilation is accomplished via either Invasive or Non-Invasive Intubation. The Non-Intubation mode also features leakage compensation, the Servo-I also has a transport mode.

**\*AVAILABLE IN INFANT AND ADULT MODES**



## REPLACEMENT SERVO-I EXPIRATORY CASSETTE

**6696947**

## HEATER & CABLES AVAILABLE



## DRAGER EVITA INFINITY V500 VENTILATOR

FOR USE WITH	PART NUMBER	DESCRIPTION
<b>V500</b>	<b>RENTAL-RM-801</b>	Fisher Paykel Heater With Cable / Probe

The Evita Infinity V500 is a highly advanced ventilation unit for use in acute care respiratory support for adult, pediatric and infant use. Delivering high-performance ventilation capabilities, comprehensive monitoring, and effective treatment functions, the Evita Infinity V500 is the ideal choice for respiratory care clinicians and intensivists alike.





# VENTILATORS

## PHILIPS TRILOGY 202 TRANSPORT VENTILATOR

FOR USE WITH	PART NUMBER	DESCRIPTION
TRILOGY	RENTAL-RM-801	Fisher Paykel Heater With Cable / Probe
	1073228	Passive Cicruit
	1073222	Active Heated Circuit



With one simple setting change, the Trilogy 202 supports either active or passive exhalation breathing circuits to accommodate changes in circuit preference. Compact design with long-life internal battery for intra-hospital transport. Supports active and passive circuits for invasive and noninvasive ventilation

### BATTERY FOR TRANSPORT

**\*Approx 3 hours of ADDITIONAL backup battery run time\***

## PHILIPS EVO VENTILATOR

FOR USE WITH	PART NUMBER	DESCRIPTION
EVO	RENTAL-RM-801	Fisher Paykel Heater With Cable/Probe

Philips Trilogy EVO ventilator delivers proven performance in noninvasive (NIV) and invasive (IV) ventilation, and is designed to stay with your patients across changing care environments. From hospital to home.



## PHILIPS EV 300 VENTILATOR

FOR USE WITH	PART NUMBER	DESCRIPTION
EV 300	RENTAL-RM-801	Fisher Paykel Heater With Cable/Probe

Transition to the future today with the next generation of Philips ventilators. The Trilogy EV300 ventilator delivers enhanced performance in noninvasive (NIV) and invasive (IV) ventilation, so patients can be treated with a single device throughout their hospital stay, regardless of changing conditions. Trilogy EV300 is designed to stay with your patients, saving your staff time and effort as patients move between hospital departments.

\*Approx 5 hours of battery run time on internal battery and 2.5 hours on external battery\*



**24 HOUR SERVICE**

YOUR JUST IN TIME RENTAL SUPPLIER

[www.valuemed.co](http://www.valuemed.co)

888-998-8633

[ValueMed.sales@gmail.com](mailto:ValueMed.sales@gmail.com)

# VENTILATORS

PURITAN BENNETT 980 VENTILATOR		
FOR USE WITH	PART NUMBER	DESCRIPTION
<b>PB 980</b>	RENTAL-RM-801	Fisher Paykel Heater With Cable / Probe
	10043551	Expiratory Filter Case of 12
	HW-1000	Heated Wire Circuit-Adult
	CIR-101	Standard Adult Circuit
<p>The Puritan Bennett 980 ventilator system helps patients breathe more naturally through innovative breath delivery technology. The Puritan Bennett 980 has an intuitive and highly configurable touch screen display that gives clinicians the options to see as little or as much information as needed including five graph and loop layout options. The 980 is equipped with an expiratory filtration system. The ventilator assurance feature will, in the event of certain system failures, will continue to deliver ventilatory support as close to the preset settings as feasible.</p>		

<p><b>PEDIATRIC</b> 7.7 lb to 77 lb 3.5 kg to 35 kg</p>	<p><b>ADULT</b> 55 lb to 330 lb 25 kg to 150 kg</p>	 <p><b>HEATER &amp; CABLES AVAILABLE</b></p>
---	---	--

PURITAN BENNETT 840 VENTILATOR		
FOR USE WITH	PART NUMBER	DESCRIPTION
<b>PB 840</b>	RENTAL-RM-801	Fisher Paykel Heater With Cable / Probe
	4-076887	Expiratory Filter Case of 12
	Max-16	Replacement Oxygen Sensor
<p>The Puritan Bennett 840 Ventilator System is A critical care ventilator. It is highly responsive and offers superior comfort, delivering sensitive, precise breaths to critically ill neonatal through adult patients.</p> <p>All units supplied with air compressor</p>		
<p><b>NEO AND ADULT MODES AVAILABLE</b></p>		



**24 HOUR SERVICE**  
YOUR JUST IN TIME RENTAL SUPPLIER

[www.valuemed.co](http://www.valuemed.co)  
888-998-8633  
[ValueMed.sales@gmail.com](mailto:ValueMed.sales@gmail.com)

# HIGH FLOW OXYGEN THERAPY



FISHER PAYKEL AIRVO 2		
FOR USE WITH	PART NUMBER	DESCRIPTION
AIRVO 2	900PT600	Red Disinfection Tube
	900PT501	Tube and Chamber Kit
	OPT942	Small Nasal Cannula
	OPT944	Medium Nasal Cannula
	OPT946	Large Nasal Cannula
	PT913	Inlet Filter / 2 pack

The AIRVO 2 system features a humidifier with integrated flow source that delivers high flows of air/oxygen mixtures to spontaneously breathing patients, through a variety of interfaces up to **60 L/min.**

The AIRVO 2 is an integrated system providing versatility, mobility and convenience.

All Airvo units have the ability to switch into junior mode

**IDEAL FOR ROOMS WITHOUT PIPED MEDICAL AIR**



FISHER PAYKEL OPTIFLOW / MAXVENTURI		
FOR USE WITH	PART NUMBER	DESCRIPTION
OPTIFLOW / MAXVENTURI	RT202	Circuit & Chamber Kit
	OPT942	Small Nasal Cannula
	OPT944	Medium Nasal Cannula
	OPT946	Large Nasal Cannula
	MAX250-E	Replacement Oxygen Sensor
	RENTAL-RM-801	Fisher Paykel Heater With Cables

The MaxVenturi has been specifically designed to work with high-flow Optiflow canulas. Using the Venturi principle, the MaxVenturi allows users to mix ambient air and oxygen without the need for piped medical-grade air. This is the perfect solution for adult high-flow oxygen therapy in almost any environment. Maxventuri delivers up to **60 L/Min of blended gas.**

**IDEAL FOR ROOMS WITHOUT PIPED MEDICAL AIR**



**24 HOUR SERVICE**  
YOUR JUST IN TIME RENTAL SUPPLIER

[www.valuemed.co](http://www.valuemed.co)  
888-998-8633  
[ValueMed.sales@gmail.com](mailto:ValueMed.sales@gmail.com)

# HIGH FLOW OXYGEN THERAPY

## VAPOTHERM-PRECISION FLOW PLUS

FOR USE WITH	PART NUMBER	DESCRIPTION
VAPOTHERM PRECISION FLOW	PF-DPC-HIGH	High Flow Kit-Circuit & Cannula 5-40 LPM
	PF-DPC-LOW	Low Flow Kit-Circuit & Cannula 1-8 LPM
	MAX250	Replacement Oxygen Sensor

Vapotherm Precision Flow Plus is designed for ease of use in mind. Control flow, oxygen, and temperature independently with the push of a single button. Vapotherm can be used on Neonates to Adults.

**FLOW UP TO 40 LPM**



## HIGH FLOW BLENDER AND FISHER PAYKEL HEATER

FOR USE WITH	PART NUMBER	DESCRIPTION
HIGH FLOW BLENDER & HEATER	RT202	Circuit & Chamber Kit
	OPT942	Small Nasal Cannula
	OPT944	Medium Nasal Cannula
	OPT946	Large Nasal Cannula
	RENTAL-RM-801	Fisher Paykel Heater With Cables

The High Flow Air/Oxygen Blender / Optiflow system uses a blender, 70 and 15 LPM flowmeter to deliver precise, humidified, blended gasses to patients up to **70 LPM**. Oxygen concentrations are adjustable from **21% to 100%**. When used in conjunction with the Optiflow nasal canulas, this system offers the ability to comfortably deliver a wide range of oxygen therapy.



**MRI AND HELI OX BLENDERS AVAILABLE**





# THE VEST AIRWAY CLEARANCE SYSTEM

HILL-ROM THE VEST		
FOR USE WITH	PART NUMBER	DESCRIPTION
<b>THE VEST UNIT</b>	P300629000	<b>X-Small Wrap</b> 19 inches-23 inches
	P300630000	<b>Small Wrap</b> 23 inches - 33 inches
	P300631000	<b>Medium Wrap</b> 33 inches-43 inches
	P300632000	<b>Large Wrap</b> 43 inches-53 inches
	P300633000	<b>X Large Wrap</b> 53 inches-67 inches
	P300634000	<b>XX Large Wrap</b> 67 inches-75 inches

The Vest Airway Clearance System is designed to assist patients in the mobilization of retained secretions. If not removed, retained secretions may contribute to increased rates of respiratory infection, hospitalization, and reduced lung function.

Through High Frequency Chest Wall Oscillation technology, The Vest® Airway Clearance System dislodges mucus from the bronchial walls, and mobilizes secretions and mucus from the smaller to larger airways where it can be cleared by coughing or suctioning.



HILL-ROM METANEB
<p>The MetaNeb System is indicated for mobilization of secretions, lung expansion therapy, the treatment and prevention of pulmonary atelectasis, and also has the ability to provide supplemental oxygen when used with compressed oxygen.</p> <p>Metaneb introduces continuous high frequency oscillation (CHFO) therapy immediately after lungs have been expanded through continuous positive expiratory pressure (CPEP) The Metaneb also integrates aerosol delivery of medications for maximum efficiency.</p>



**24 HOUR SERVICE**  
YOUR JUST IN TIME RENTAL SUPPLIER

www.valuemed.com  
888-998-8633  
ValueMed.sales@gmail.com

# OTHER THERAPY EQUIPMENT

## RESPIRONICS COUGH ASSIST

Cough Assist safely removes broncho-pulmonary secretions by stimulating individual to cough. This is a desired approach to respiratory therapy as it's less invasive over suctioning the bronchial secretions. Respiratory Therapy is vital for individuals with respiratory conditions that make it difficult to cough and therefore mucus builds up which increases risk of respiratory infections. This model offers both automatic and manual modes of operation. Therapy involves slow inhale and rapid exhale of airflow to create positive to negative pressure. This loosens the mucus to stimulate a cough consisting of five coughing cycles.



## COUGH ASSIST & T-70

FOR USE WITH	PART NUMBER	DESCRIPTION
<b>COUGH ASSIST &amp; T-70</b>	<b>1090832</b>	Cough Assist Circuit, Small Mask-6 ft
	<b>1090833</b>	Cough Assist Circuit, Medium Mask-6 ft
	<b>1090834</b>	Cough Assist Circuit, Large Mask-6 ft

## PHILIPS RESPIRONICS COUGH ASSIST T-70

CoughAssist T-70 is a mechanical insufflation-exsufflation device designed to noninvasively clear secretions from the lungs by simulating a natural cough. Similar to a normal deep breath, CoughAssist gradually applies positive air pressure (insufflation) to obtain a large volume of air within the lungs. The device then quickly reverses the flow of air by shifting to negative air pressure. The resulting high expiratory flow helps mobilize secretions out of the airway as a deep, natural cough would do.



# SUCTION REGULATORS AND ACCESORIES



## ValueMed

### TOTAL EQUIPMENT SOLUTIONS

**\*\*MEDICAL GAS SHUTDOWN SERVICES\*\*LONG TERM  
& ON DEMAND RENTALS\*\*MEDICAL GAS TESTING AND  
CERTIFICATIONS\*\*SALES\*\*REPAIRS\*\***

Ohio Int / Cont	Ohio Push to Set	Ohio Continuous	Gentec	Boehringer	Precision Medical

#### SUCTION REGULATOR QUICK CONNECT **BACK / WALL CONNECTOR** OPTIONS

130-18	25-999	531-18	431-18	331-18	332-18	231-18

#### SUCTION REGULATOR **BOTTOM CONNECTOR** OPTIONS

	1/8" NPT	<b>SUCTION REGULATOR OVERFLOW SAFETY TRAP</b>			
	DISS Male, Vacuum				
	25-132-02				
	Tubing Nipple				
	Vacuum Regulator				
	25-999				

## YOUR JUST IN TIME RENTAL SUPPLIER

**24 HOUR SERVICE**

**888-998-8633**

ValueMed.Sales@gmail.com www.  
valuemed.co  
888-998-8633

# SUCTION REGULATORS

## OHIO / OHMEDA SUCTION REGULATORS

		OHIO / OHMEDA							
		MODEL	INLET / OUTLET	DISS FEMALE	BARBED HOSE STEM	OHMEDA	CHEMETRON	OXEQUIP	MEDSTAR
	CONTINUOUS / INTERMITTENT	DISS MALE	H-2-130-55	H-2-77-55	H-2-531-55	H-2-431-55	H-2-331-55	H-2-330-55	H-2-231-55
		HOSE BARB	H-2-130-77	H-2-77-77	H-2-531-77	H-2-431-77	H-2-331-77	H-2-330-77	H-2-231-77
	CONTINUOUS	DISS MALE	H-3-130-55	H-3-77-55	H-3-531-55	H-3-431-55	H-3-331-55	H-3-330-55	H-3-231-55
		HOSE BARB	H-3-130-77	H-3-77-77	H-3-531-77	H-3-431-77	H-3-331-77	H-3-330-77	H-3-231-77
	SURGERY	DISS MALE	H-4-130-55	H-4-77-55	H-4-531-55	H-4-431-55	H-4-331-55	H-4-330-55	H-4-231-55
		HOSE BARB	H-4-130-55	H-4-77-77	H-4-531-77	H-4-431-77	H-4-331-77	H-4-330-77	H-4-231-77
OHIO / OHMEDA CONT / INT	PEDIATRIC CONTINUOUS / INTERMITTENT	DISS MALE	H-5-130-55	H-5-77-55	H-5-531-55	H-5-431-55	H-5-331-55	H-5-330-55	H-5-231-55
	HOSE BARB	H-5-130-55	H-5-77-77	H-5-531-77	H-5-431-77	H-5-331-77	H-5-330-77	H-5-231-77	

		OHIO / OHMEDA - PUSH TO SET							
		MODEL	INLET / OUTLET	DISS FEMALE	BARBED HOSE STEM	OHMEDA	CHEMETRON	OXEQUIP	MEDSTAR
	CONTINUOUS / INTERMITTENT	DISS MALE	HP-2-130-55	HP-2-77-55	HP-2-531-55	HP-2-431-55	HP-2-331-55	HP-2-330-55	HP-2-231-55
		HOSE BARB	HP-2-130-77	HP-2-77-77	HP-2-531-77	HP-2-431-77	HP-2-331-77	HP-2-330-77	HP-2-231-77
	CONTINUOUS	DISS MALE	HP-3-130-55	HP-3-77-55	HP-3-531-55	HP-3-431-55	HP-3-331-55	HP-3-330-55	HP-3-231-55
		HOSE BARB	HP-3-130-77	HP-3-77-77	HP-3-531-77	HP-3-431-77	HP-3-331-77	HP-3-330-77	HP-3-231-77
	SURGERY	DISS MALE	HP-4-130-55	HP-4-77-55	HP-4-531-55	HP-4-431-55	HP-4-331-55	HP-4-330-55	HP-4-231-55
		HOSE BARB	HP-4-130-55	HP-4-77-77	HP-4-531-77	HP-4-431-77	HP-4-331-77	HP-4-330-77	HP-4-231-77
PUSH TO SET CONT / INT	PEDIATRIC CONTINUOUS / INTERMITTENT	DISS MALE	HP-5-130-55	HP-5-77-55	HP-5-531-55	HP-5-431-55	HP-5-331-55	HP-5-330-55	HP-5-231-55
	HOSE BARB	HP-5-130-55	HP-5-77-77	HP-5-531-77	HP-5-431-77	HP-5-331-77	HP-5-330-77	HP-5-231-77	









		AMVEX							
		MODEL	INLET / OUTLET	DISS FEMALE	BARBED HOSE STEM	OHMEDA	CHEMETRON	OXEQUIP	MEDSTAR
	CONTINUOUS / INTERMITTENT	DISS MALE	A-2-130-55	A-2-77-55	A-2-531-55	A-2-431-55	A-2-331-55	A-2-330-55	A-2-231-55
		HOSE BARB	A-2-130-77	A-2-77-77	A-2-531-77	A-2-431-77	A-2-331-77	A-2-330-77	A-2-231-77
	CONTINUOUS	DISS MALE	A-3-130-55	A-3-77-55	A-3-531-55	A-3-431-55	A-3-331-55	A-3-330-55	A-3-231-55
		HOSE BARB	A-3-130-77	A-3-77-77	A-3-531-77	A-3-431-77	A-3-331-77	A-3-330-77	A-3-231-77
	SURGERY	DISS MALE	A-4-130-55	A-4-77-55	A-4-531-55	A-4-431-55	A-4-331-55	A-4-330-55	A-4-231-55
		HOSE BARB	A-4-130-55	A-4-77-77	A-4-531-77	A-4-431-77	A-4-331-77	A-4-330-77	A-4-231-77
AMVEX CONT / INT	PEDIATRIC CONTINUOUS / INTERMITTENT	DISS MALE	A-5-130-55	A-5-77-55	A-5-531-55	A-5-431-55	A-5-331-55	A-5-330-55	A-5-231-55
	HOSE BARB	A-5-130-55	A-5-77-77	A-5-531-77	A-5-431-77	A-5-331-77	A-5-330-77	A-5-231-77	





# SUCTION REGULATORS

## BOEHRINGER SUCTION REGULATORS

	BOEHRINGER								
	MODEL	INLET / OUTLET	DISS FEMALE	BARBED HOSE STEM	OHMEDA	CHEMETRON	OXEQUIP	MEDSTAR	PURITAN BENNETT
									
CONTINUOUS / INTERMITTENT 3804	DISS MALE	BT-2-130-55	BT-2-77-55	BT-2-531-55	BT-2-431-55	BT-2-331-55	BT-2-330-55	BT-2-231-55	
	HOSE BARB	BT-2-130-77	BT-2-77-77	BT-2-531-77	BT-2-431-77	BT-2-331-77	BT-2-330-77	BT-2-231-77	
CONTINUOUS 3800	DISS MALE	BT-3-130-55	BT-3-77-55	BT-3-531-55	BT-3-431-55	BT-3-331-55	BT-3-330-55	BT-3-231-55	
	HOSE BARB	BT-3-130-77	BT-3-77-77	BT-3-531-77	BT-3-431-77	BT-3-331-77	BT-3-330-77	BT-3-231-77	
SURGERY 3840	DISS MALE	BT-4-130-55	BT-4-77-55	BT-4-531-55	BT-4-431-55	BT-4-331-55	BT-4-330-55	BT-4-231-55	
	HOSE BARB	BT-4-130-55	BT-4-77-77	BT-4-531-77	BT-4-431-77	BT-4-331-77	BT-4-330-77	BT-4-231-77	
BOEHRINGER PEDIATRIC CONTINUOUS / INTERMITTENT 3814	DISS MALE	BT-5-130-55	BT-5-77-55	BT-5-531-55	BT-5-431-55	BT-5-331-55	BT-5-330-55	BT-5-231-55	
	HOSE BARB	BT-5-130-55	BT-5-77-77	BT-5-531-77	BT-5-431-77	BT-5-331-77	BT-5-330-77	BT-5-231-77	

\*\*\*\*PROTECT YOUR SUCTION EQUIPMENT\*\*\*\*

### SUCTION REGULATOR OVERFLOW SAFETY TRAP

DISS FEMALE	ADD "T" TO SUCTION REGULATOR PART NUMBER FOR TRAP	LOCKING GLAND
		
<b>130-1000</b>		<b>295-1000</b>

### OVERFLOW SAFETY TRAP FEATURES AND BENEFITS

- ✓ Limit the contamination risk of the regulator and the vacuum pipeline network.
- ✓ Unique float design ensures maximum vacuum flow and positive shutoff.
- ✓ Clear, shatter resistant polycarbonate bottle can be steam or sterilized after using.
- ✓ It helps prevent aspirate from entering the regulator as a result of misuse and extends the life of suction equipment and pipeline systems.

Meets NFPA and ASTM standards





**24 HOUR SERVICE**  
YOUR JUST IN TIME RENTAL SUPPLIER

www.valuemed.co  
888-998-8633  
ValueMed.sales@gmail.com

# SUCTION REGULATORS

		PRECISION MEDICAL							
		MODEL	INLET / OUTLET	BARBED HOSE STEM	CHEMETRON	DISS FEMALE	OHMEDA	PURITAN BENNETT	OXEQUIP
	2 MODE CONTINUOUS	DISS MALE	PM3021	PM3016	PM3014	PM3015	PM3019	PM3017	PM3018
		HOSE BARB	PM3010	PM3005	PM3003	PM3004	PM3008	PM3006	PM3007
	3 MODE CONTINUOUS	DISS MALE	PM3121	PM3116	PM3114	PM3115	PM3119	PM3117	PM3118
		HOSE BARB	PM3110	PM3105	PM3103	PM3104	PM3108	PM3106	PM3107
	CONTINUOUS INTERMITTENT	DISS MALE	PM3321	PM3316	PM3314	PM3315	PM3319	PM3317	PM3318
		HOSE BARB	PM3310	PM3305	PM3303	PM3304	PM3308	PM3306	PM3307
PRECISION MEDICAL CONT / INT	PEDIATRIC	DISS MALE	PM3421	PM3416	PM3414	PM3415	PM3419	PM3417	PM3418
		HOSE BARB	PM3410	PM3405	PM3403	PM3404	PM3408	PM3406	PM3407





		CHEMETRON							
		MODEL	INLET / OUTLET	DISS FEMALE	BARBED HOSE STEM	OHMEDA	CHEMETRON	OXEQUIP	MEDSTAR
	CONTINUOUS / INTERMITTENT	DISS MALE	C-2-130-55	C-2-77-55	C-2-531-55	C-2-431-55	C-2-331-55	C-2-330-55	C-2-231-55
		HOSE BARB	C-2-130-77	C-2-77-77	C-2-531-77	C-2-431-77	C-2-331-77	C-2-330-77	C-2-231-77
	CONTINUOUS	DISS MALE	C-3-130-55	C-3-77-55	C-3-531-55	C-3-431-55	C-3-331-55	C-3-330-55	C-3-231-55
		HOSE BARB	C-3-130-77	C-3-77-77	C-3-531-77	C-3-431-77	C-3-331-77	C-3-330-77	C-3-231-77
	SURGERY	DISS MALE	C-4-130-55	C-4-77-55	C-4-531-55	C-4-431-55	C-4-331-55	C-4-330-55	C-4-231-55
		HOSE BARB	C-4-130-55	C-4-77-77	C-4-531-77	C-4-431-77	C-4-331-77	C-4-330-77	C-4-231-77
CHEMETRON CONT / INT	PEDIATRIC CONTINUOUS / INTERMITTENT	DISS MALE	C-5-130-55	C-5-77-55	C-5-531-55	C-5-431-55	C-5-331-55	C-5-330-55	C-5-231-55
		HOSE BARB	C-5-130-55	C-5-77-77	C-5-531-77	C-5-431-77	C-5-331-77	C-5-330-77	C-5-231-77

		GENTEC							
		MODEL	INLET / OUTLET	DISS FEMALE	BARBED HOSE STEM	OHMEDA	CHEMETRON	OXEQUIP	MEDSTAR
	CONTINUOUS / INTERMITTENT	DISS MALE	G-2-130-55	G-2-77-55	G-2-531-55	G-2-431-55	G-2-331-55	G-2-330-55	G-2-231-55
		HOSE BARB	G-2-130-77	G-2-77-77	G-2-531-77	G-2-431-77	G-2-331-77	G-2-330-77	G-2-231-77
	CONTINUOUS	DISS MALE	G-3-130-55	G-3-77-55	G-3-531-55	G-3-431-55	G-3-331-55	G-3-330-55	G-3-231-55
		HOSE BARB	G-3-130-77	G-3-77-77	G-3-531-77	G-3-431-77	G-3-331-77	G-3-330-77	G-3-231-77
	SURGERY	DISS MALE	G-4-130-55	G-4-77-55	G-4-531-55	G-4-431-55	G-4-331-55	G-4-330-55	G-4-231-55
		HOSE BARB	G-4-130-55	G-4-77-77	G-4-531-77	G-4-431-77	G-4-331-77	G-4-330-77	G-4-231-77
GENTEC CONT / INT	PEDIATRIC CONTINUOUS / INTERMITTENT	DISS MALE	G-5-130-55	G-5-77-55	G-5-531-55	G-5-431-55	G-5-331-55	G-5-330-55	G-5-231-55
		HOSE BARB	G-5-130-55	G-5-77-77	G-5-531-77	G-5-431-77	G-5-331-77	G-5-330-77	G-5-231-77



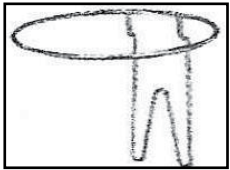

# SUCTION REGULATORS

## SUCTION CANISTER RINGS

<b>BEMIS WALL CANISTER RING - METAL</b>			
Accommodates Bemis 800cc Canister	<b>4 3/4" ID</b>	<b>534510</b>	
Accommodates Bemis 1200, 2000 & 3000cc Canisters	<b>5 5/8" ID</b>	<b>532810</b>	
Accommodates Medi-Vac 1200cc Guardian Canister	<b>4 3/4" ID</b>	<b>534510</b>	
<b>BEMIS WALL CANISTER RING - PLASTIC</b>			
Accommodates 1200cc, 2000cc & 3000cc Bemis Canister	<b>5 5/8" ID</b>	<b>532710</b>	
<b>ALLIED HEALTHCARE CANISTER RING</b>			
Accommodates 1500 & 2400ml Allied Canisters	<b>5 1/4" ID</b>	<b>02-0150</b>	
<b>CARDINAL STANDARD CANISTER RING</b>			
Accommodates Cardinal 1000cc Canister	<b>4 3/8" ID</b>	<b>65652-584</b>	
Accommodates Cardinal 1200cc Canister	<b>4 3/8" ID</b>	<b>65652-584</b>	
Accommodates Cardinal 1500cc Canister	<b>5 1/8" ID</b>	<b>65652-563</b>	
Accommodates Cardinal 3000cc Canister	<b>6 3/4" ID</b>	<b>65652-561</b>	
Accommodates Medi-Vac 1200cc & Guardian / Bemis 800cc Canister	<b>4 3/8" ID</b>	<b>65652-584</b>	

## FOUR CANISTER CARRIERS

**\*\*STANDS COME WITHOUT RINGS\*\***

<b>ALLIED / CHEMETRON</b>		<b>BEMIS</b>		<b>CARDINAL</b>	
					
<b>20-02-0023</b>	<b>36" Tall</b>	<b>533910</b>	<b>ADJUSTABLE</b>	<b>652-586</b>	<b>30" Tall</b>







**24 HOUR SERVICE**  
YOUR JUST IN TIME RENTAL SUPPLIER





[www.valuemed.co](http://www.valuemed.co)  
888-998-8633  
[ValueMed.sales@gmail.com](mailto:ValueMed.sales@gmail.com)

# SUCTION SUPPLIES



## CANISTERS & ACCESSORIES

CARDINAL		BEMIS		ALLIED	
					
<b>65651-212</b>	1200cc Stem 40/CS	<b>424410</b>	800cc Stem 100/CS	<b>08-0003</b>	1500ML Stem 48/Case
<b>65651-220</b>	2000cc Stem 40/CS	<b>434410</b>	1200cc Stem 48/CS	<b>08-0004</b>	1500ML DISS 48/Case
<b>65651-230</b>	3000cc Stem 40/CS	<b>435410</b>	2000cc Stem 48/CS	<b>08-0002</b>	2400ML Stem 36/Case
				<b>08-0001</b>	2400ML DISS 36/Case

DISPOSABLE SUCTION TUBING			
Suction Tubing, 6 Ft	<b>536010</b>	<b>25/Cs</b>	
Suction Tubing, 1.5 Ft	<b>536510</b>	<b>50/Cs</b>	

	<b>Metal Female DISS x Universal Tubing Barb</b>	<b>531410</b>
	<b>Plastic Female DISS with 1/8\" NPT Adapter</b>	<b>65652-131</b>
	<b>Female Diss x Tubing Barb</b>	<b>531110</b>
	<b>1/8\" Male NPT x DISS x Universal Tubing Barb</b>	<b>531110</b>

	Main Line Suction Full Demand	
	INLET	PART#
	DISS Female Inlet	40-131
	Ohmeda Inlet	40-531
	Chemetron / NCG Inlet	40-431
	Oxequip Inlet	40-331
	Medstar Inlet	40-332
	Puritan Bennett Inlet	40-231

INCLINE VACUUM ON/OFF VALVE		
	Plastic	<b>#45-65652-580</b>
	Metal	1/8\" NPT
		<b>#45-7064</b>

WALL MOUNT SUCTION CANISTER HOLDERS			
	Plastic	<b>#22-11-0006</b>	Aluminum
			

OVERFLOW FILTER SET-UP

<b>3100-01 Flexi-Filter</b>
3100-44 Flexi-Filter with Elbow

CEILING MOUNT 7\" LONG ADAPTER

<b>**Adapter Only** 852</b>

Bottle Holder

<b>#22-11-0004</b>





# MEDGAS OUTLETS AND REBUILD KITS

ValueMed.Sales@gmail.com  
www.valuemed.co  
888-998-8633



# ValueMed

## YOUR MEDICAL GAS SPECIALISTS

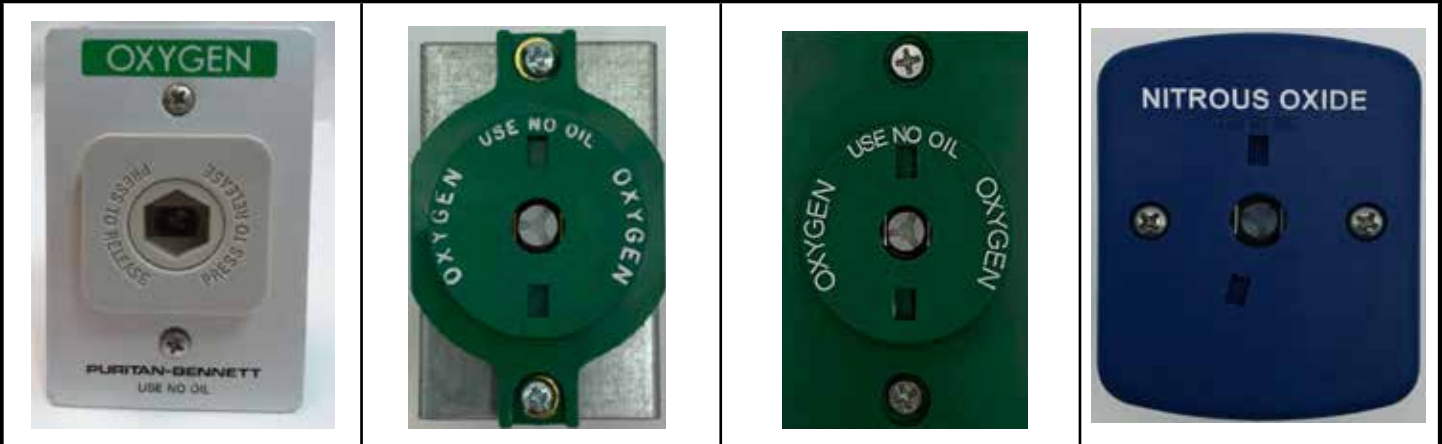

**CALL FOR A QUOTE TODAY**

888-998-8633

Valuemed.co

# MEDICAL GAS OUTLETS

## OHIO / PIN / DIAMOND INDEX CONNECTION

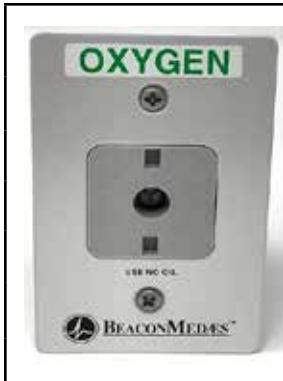

SERIES B - OHIO INDEX / PIN			
GAS	CONSOLE ROUGH IN	WALL ROUGH IN	FINISH ASSEMBLY
Oxygen	233010-00	233110-00	230940-00
Medical Air	233012-00	233112-00	230942-00
Vacuum	233013-00	233113-00	230943-00
Nitrous	233011-00	233111-00	230941-00
WAGD	233019-00	233119-00	230946-00



DIAMOND CARE - OHIO			
GAS	WALL ROUGH IN	FINISH ASSEMBLY	CONSOLE
Oxygen	4107-2234-00	4107-2146-00	4107-2146-34
Medical Air	4107-2234-03	4107-2146-02	4107-2146-35
Vacuum	4107-2234-02	4107-2146-03	4107-2146-37
Nitrous	4107-2234-01	4107-2146-01	4107-2146-36
WAGD	4107-2234-04	4107-2146-04	4107-2146-38



DIAMOND III / GEMINI WALL OUTLET		
GAS	WALL ROUGH IN	FINISH ASSEMBLY
Oxygen	6-234510-00	6-234610-00
Medical Air	6-234512-00	6-234612-00
Vacuum	6-234513-00	6-234613-00
Nitrous	6-234511-00	6-234611-00
WAGD	6-234519-00	6-234619-00



GEMINI CONSOLE OUTLET		
GAS	WALL ROUGH IN	FINISH ASSEMBLY
Oxygen	6-234410-00	6-234810-00
Medical Air	6-234412-00	6-234812-00
Vacuum	6-234413-00	6-234813-00
Nitrous	6-234411-00	6-234811-00
WAGD	6-234419-00	6-234819-00

**\*\*THE BEST WAY TO REPAIR YOUR HOSPITAL GAS OUTLETS IS TO REPLACE THE FRONT FINISH ASSEMBLY\*\***



DIAMOND III CONSOLE OUTLET	
GAS	FINISH ASSEMBLY
Oxygen	4107-2097-45
Medical Air	4107-2097-48
Vacuum	4107-2097-47



# MEDICAL GAS OUTLETS

## PURITAN BENNETT / GEOMETRIC INDEX CONNECTION



SERIES B - PURITAN BENNETT			
GAS	CONSOLE ROUGH IN	WALL ROUGH IN	FINISH ASSEMBLY
Oxygen	233010-00	233110-00	230930-00
Medical Air	233012-00	233112-00	230932-00
Vacuum	233013-00	233113-00	230933-00
Nitrous	233010-00	233111-00	230930-00
WAGD	233019-00	233119-00	230939-00



DIAMONDCARE - PURITAN BENNETT			
GAS	WALL ROUGH IN	FINISH ASSEMBLY	CONSOLE
Oxygen	4107-2234-00	4107-2145-92	4107-2146-26
Medical Air	4107-2234-03	4107-2145-94	4107-2146-27
Vacuum	4107-2234-02	4107-2145-95	4107-2146-29
Nitrous	4107-2234-01	4107-2145-93	4107-2146-28
WAGD	4107-2234-06	4107-2145-96	4107-2146-30

## MEDSTAR CONNECTION



MEDSTAR		
	COMPLETE OUTLET	REPLACEMENT VALVE KIT
OXYGEN	1930-2111	1227-X
MEDICAL AIR	1930-2411	1227-X
NITROUS OXIDE	1930-2311	1227-X
VACUUM	1930-2211	1227-X
WAGD	1930-2811	1227-X
CARBON DIOXIDE	1930-2511	1227-X

## DISS INDEX CONNECTION



CHEMETRON DISS 560 SERIES		
	COMPLETE OUTLET ASSEMBLY	REPLACEMENT VALVE KIT
OXYGEN	64-04-5601	64-90-0631
MEDICAL AIR	64-04-5603	64-90-0634
NITROUS OXIDE	64-04-5604	64-90-0633
VACUUM	64-04-5602	64-90-0632
WAGD	64-04-5606	64-90-0638
N2	64-04-5607	64-90-0636
CO2	64-04-5608	64-90-0635



**24 HOUR SERVICE**  
YOUR JUST IN TIME RENTAL SUPPLIER

www.valuemed.co  
888-998-8633  
ValueMed.sales@gmail.com

# MEDICAL GAS OUTLETS

## CHEMETRON / LATCH INDEX CONNECTION



CHEMETRON 500 SERIES			
COMPLETE OUTLET ASSEMBLY		VALVE BODY ASSEMBLY	COVER PLATE
OXYGEN	64-01-5001	64-90-0620	64-91-1501
VACUUM	64-01-5002	64-90-0621	64-91-1502
MEDICAL AIR	64-01-5003	64-90-0620	64-91-1503
NITROUS OXIDE	64-01-5004	64-90-0620	64-91-1504
WAGD	64-01-5006	64-90-0621	64-91-1506
CARBON DIOXIDE	64-01-5007	64-90-0620	64-91-1507
O2/CO2	64-01-5008	64-90-0620	64-91-1508
SLIDE BRACKET	64-06-001		



CHEMETRON 400 SERIES			
COMPLETE OUTLET ASSEMBLY		VALVE BODY ASSEMBLY	COVER PLATE
OXYGEN	64-20-001	64-90-0180	64-92-0176
MEDICAL AIR	64-20-002	64-90-0180	64-92-0178
NITROUS OXIDE	64-20-006	64-90-0180	64-91-4003
VACUUM	64-20-005	64-90-0181	64-92-0177



SERIES B - CHEMETRON			
GAS	CONSOLE ROUGH IN	WALL ROUGH IN	FINISH ASSEMBLY
OXYGEN	233010-00	233110-00	230950-00
MEDICAL AIR	233012-00	233112-00	230952-00
VACUUM	233013-00	233113-00	230953-00
NITROUS	233011-00	233111-00	230951-00
WAGD	233019-00	233119-00	230959-00



DIAMONDCARE - CHEMETRON			
GAS	WALL ROUGH IN	FINISH ASSEMBLY	CONSOLE
OXYGEN	4107-2234-00	4107-2146-08	4107-2146-42
MEDICAL AIR	4107-2234-03	4107-2146-10	4107-2146-43
VACUUM	4107-2234-02	4107-2146-11	4107-2146-45
NITROUS	4107-2234-01	4107-2146-09	4107-2146-44
WAGD	4107-2234-06	4107-2146-12	4107-2146-46







# MEDICAL GAS OUTLETS

## HORIZON HEADWALL OUTLET STATIONS

**VALUEMED OFFERS  
FULL REPAIR AND REFURBISHMENT  
OF ALL TYPES OF HEADWALL  
GAS BLOCKS**

<b>OXYGEN</b>		
CLIP ONLY	#877	
<b>MEDICAL AIR</b>		
CLIP ONLY	#878	
<b>VACUUM</b>		
CLIP ONLY	#876	

	<b>Standard for most Hospital Headwalls is bottom hose connection</b>			
	<b>HOSE FROM THE BOTTOM</b>		<b>HOSE FROM THE BACK</b>	
	<b>OHIO</b>		<b>OHIO</b>	
	Oxygen	Z-42-500	Oxygen	ZB-42-500
	Medical Air	Z-42-510	Medical Air	ZB-42-510
	Vacuum	Z-42-530	Vacuum	ZB-42-530
	<b>Gas Block, Clip &amp; 4 Foot Hose Included</b>			

	<b>Standard for most Hospital Headwalls is bottom hose connection</b>			
	<b>HOSE FROM THE BOTTOM</b>		<b>HOSE FROM THE BACK</b>	
	<b>CHEMETRON</b>		<b>CHEMETRON</b>	
	Oxygen	Z-42-400	Oxygen	ZB-42-400
	Medical Air	Z-42-410	Medical Air	ZB-42-410
	Vacuum	Z-42-430	Vacuum	ZB-42-430
	<b>Gas Block, Clip &amp; 4 Foot Hose Included</b>			

	<b>Standard for most Hospital Headwalls is bottom hose connection</b>			
	<b>HOSE FROM THE BOTTOM</b>		<b>HOSE FROM THE BACK</b>	
	<b>PURITAN BENNETT</b>		<b>PURITAN BENNETT</b>	
	Oxygen	Z-42-200	Oxygen	ZB-42-200
	Medical Air	Z-42-210	Medical Air	ZB-42-210
	Vacuum	Z-42-230	Vacuum	ZB-42-230
	<b>Gas Block, Clip &amp; 4 Foot Hose Included</b>			





**24 HOUR SERVICE**  
YOUR JUST IN TIME RENTAL SUPPLIER

[www.valuemed.co](http://www.valuemed.co)  
888-998-8633  
[ValueMed.sales@gmail.com](mailto:ValueMed.sales@gmail.com)

# PIPELINE EQUIPMENT

## Series B Rebuild Kits

	Repair Kit Chemetron/Latch Index Pressure	4107-400-465	
	Repair Kit Chemetron/Latch Index Vacuum	4107-400-466	
	Repair Kit Ohio/Pin Index All Gases	4107-400-467	
	Repair Kit Puritan Bennett/Geometric Pressure	4107-400-468	
	Repair Kit Puritan Bennett/Geometric Vacuum	4107-400-469	
	Repair Kit -Rough In / Secondary	4107-400-470	
	* Kits Are For 10 Outlet Rebuilds		



## Series B Rough In Secondary Repair Kit

Repair Kit Secondary	4107-400-470
* Kits Are For 10 Outlet Rebuilds	

## Gemini Rebuild Kits

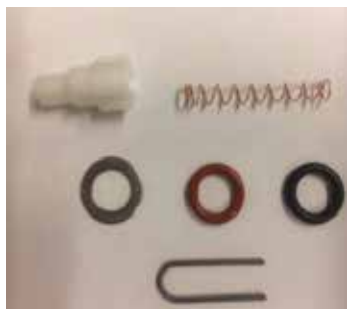
	Repair Kit Ohio Primary	290804-PG	
	Repair Kit Ohio Secondary Pressure	290802-PG	
	Repair Kit Ohio Secondary Vacuum	290803-PG	
	* Kits Are For 10 Outlet Rebuilds		

## GEMINI KEYING DISKS

	<b>GAS</b>	<b>Part Number</b>
	Oxygen	6-616318-10
	Medical Air	6-616318-12
	Vacuum	6-616318-13
	Nitrous	6-616318-11
	WAGD	6-616318-19

## Gemini / Diamond III Rough In Secondary Repair Kit

	
Repair Kit Rough in Vacuum	290803-PG
* Kits Are For 10 Outlet Rebuilds	

## DIAMOND III KEYING DISKS



	<b>GAS</b>	<b>Part Number</b>
	Oxygen	0221-3919-600
	Medical Air	0221-3921-600
	Vacuum	0221-3920-600
	Nitrous	0221-3915-600

	<b>GEMINI SECONDARY CHECK</b>
	6-525344-00
	SOLD EACH



# OUTLET REBUILD KITS / PARTS



## Diamondcare Rebuild Kits

	Primary Repair Kit Ohio/Pin Index	6803-7030-117	
	Primary Repair Kit Chemetron/Latch Index	6803-7030-118	
	Primary Repair Kit Puritan Bennet/Geometric	6803-7030-119	
	Secondary Repair Kit Pressure	6803-7030-124	
	Secondary Repair Kit Vacuum	6803-7030-125	
	* Kits Are For 10 Outlet Rebuilds		

## Original Diamond 1 Rebuild Kit

	Original Diamond 1 Front Repair Kit	4107-201-203	
	* Kit is for repair of one outlet		

## Diamond 1 Keying Disk with Ears

Oxygen Disk	4107-400-614		
Air Disk	4107-400-622		
Vacuum Disk	4107-400-616		

## Chemetron 400 & 500 Series O-Ring Kits

	O-Ring-for Valve Body-12pk	64-90-0186	
	O-Ring for Poppet-12pk	64-90-0017	
	O-Ring for Housing-12pk	64-90-0085	

### 400 Series Valve Body With Poppet & O-Rings-VAC & Pressure

64-90-0180



### 500 Series Valve Body With Poppet & O-Rings-VACUUM ONLY

64-90-0621



### 400 Series Valve Body With Poppet & O-Rings-PRESSURE ONLY

64-90-0620



**24 HOUR SERVICE**

YOUR JUST IN TIME RENTAL SUPPLIER







[www.valuemed.co](http://www.valuemed.co)



888-998-8633

[ValueMed.sales@gmail.com](mailto:ValueMed.sales@gmail.com)





# PIPELINE & EQUIPMENT GAUGES

## PRESSURE AND VACUUM GAUGES

					
<b>MG-C2</b>	<b>MG-C23</b>	<b>MJ-C1P</b> Gauge with Rubber Protector	<b>MG-C29</b>	<b>MG-C58</b> Gomco 300 Gauge 01-90-3059	<b>MC-C14</b>

<b>MG-C2</b>	4000 PSI	2" OD	1/4" NPT	Chrome	<b>Teflon Tape</b>  <b>TFE-40</b>	<b>Leak Test Solution</b>  <b>LD-8</b>
<b>MG-C3</b>	100 PSI	1 1/2" OD	1/8" NPT	Chrome		
<b>MG-C4</b>	100 PSI	2" OD	1/4" NPT	Chrome		
<b>MG-C7</b>	15 LPM	2" OD	1/4" NPT	Chrome		
<b>MG-C23</b>	4000 PSI	1 1/2" OD	1/8" NPT	Chrome		
<b>MG-C75</b>	3000 PSI	1 1/2" OD	1 1/2" NPT	Chrome		
<b>MG-C75P</b>	3000 PSI	1 1/2" OD	1 1/2" NPT	Chrome		

BOTTOM PORT					BACK PORT				
<b>MG-C9</b>	4000 psi	2" OD	1/4" NPT	Chrome	<b>MG-B57</b>	100 psi	1-1/2" OD	1/8" NPT	Black
<b>MG-C11</b>	100 psi	2" OD	1/4" NPT	Chrome	<b>MG-B59</b>	300 psi	1-1/2" OD	1/8" NPT	Black
<b>MG-C13</b>	4000 psi	1-1/2" OD	1/8" NPT	Chrome	<b>REPLACEMENT LENSES</b>				
<b>MG-C14</b>	30 psi	2" OD	1/4" NPT	Chrome	<b>MGL-15</b>	Screw-On Type for 1-1/2" Chrome Gauges			
<b>MG-C15</b>	60 psi	2" OD	1/4" NPT	Chrome	<b>MGL-15WS</b>	Snap-In Type for 1-1/2" Gauges			
<b>MG-C16</b>	200 psi	2" OD	1/4" NPT	Chrome	<b>MGL-20</b>	Screw-On Type for 2" Chrome and Black Gauges			
<b>MG-C17</b>	400 psi	2" OD	1/4" NPT	Chrome	<b>MGL-70</b>	Snap-In Type for 2-1/2" Suction Gauges			
<b>MG-C18</b>	600 psi	2" OD	1/4" NPT	Chrome	<b>VACUUM</b>				
<b>MG-C19</b>	1000 psi	2" OD	1/4" NPT	Chrome	<b>MG-C58</b>	30 inHg Vac Back Port	1-1/2" OD	1/8" NPT	Chrome
<b>NITROUS OXIDE Blue face w/ white letters</b>					<b>MG-B76</b>	200 mm HG/ Bottom Port	2" OD	1/8" NPT	Black
<b>MG-C29</b>	2000 psi	2" OD	1/4" NPT	Chrome					
<b>MG-C30</b>	100 psi	2" OD	1/4" NPT	Chrome					

REPLACEMENT SUCTION REGULATOR GAUGES							
							
<b>BOEHRINGER 1/8" NPT</b>	<b>BG-300</b>	<b>OHIO/ OHMEDA</b>	<b>HG-300</b>	<b>PRECISION</b>	<b>PG-300</b>	<b>CHEMETRON</b>	<b>CG-300</b>
<b>OXEQUIP 1/4" NPT</b>	<b>OX-300</b>	<b>AMVEX</b>	<b>AM-300</b>				





# OUTLET TESTING TOOLS

## OUTLET ACCESSORIES / WALL OUTLET TESTER



Hospital Wall Outlet Test Gauge for Checking Gas Line Flow & Pressure  
ALL GASSES

OUTLET	O2	AIR	N2O	VAC	N2	INST AIR
DISS	20-DT	21-DT	24-DT	25-DT	26-DT	34-DT
OHIO	20-OT	21-OT	24-OT	25-OT	26-OT	34-OT
CHEMETRON	20-CT	21-CT	24-CT	25-CT	26-CT	34-CT
MEDSTAR	20-MT	21-MT	24-MT	25-MT	26-MT	34-MT
PURITAN BENNETT	20-PT	21-PT	24-PT	25-PT	26-PT	34-PT

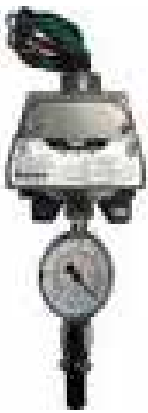

### MASTER ALARM PRESSURE / VACUUM SWITCH

#### DEMAND CHECK FITTINGS (GAS SPECIFIC)

	ALLIED	BEACON
OXYGEN	13-0100	6-129030-10
MEDICAL AIR	13-0103	6-129030-12
NITROUS OXIDE	13-0102	6-129030-11
CARBON DIOXIDE	13-0104	6-129030-20
VACUUM	13-0107	6-129030-13
WAGD	13-0107	6-129030-19
NITROGEN	*13-0105	6-129030-14
INSTRUMENT AIR	*13-0130	6-129030-18

\*Requires 2 Switches

### O-Ring Lubricant



64-90-2111

For Medical Gas & Vacuum Outlets

### ENVIROVAC



64-90-VAC

Outlet Cleaner

### Zone Valve Box Replacement Gauges

1.5" Gauge  
1/8" NPT Back Port

100 PSI MG-BW-70

300 PSI MG-BW-71

30 In/Hg MG-BW-72



### 4 1/2" Gauge With 1/4" NPT

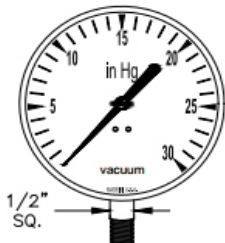

VACUUM GAUGE

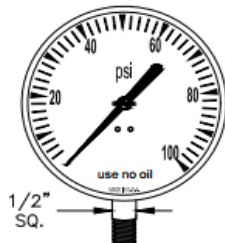

LOW PRESSURE (PRESSURE GAUGE)

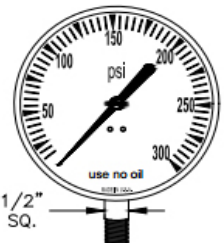

HIGH PRESSURE (NITROGEN GAUGE)

### Steel-Case Gauges

PART NUMBER	ITEM
6-130111-00	Vacuum Gauge (30 in. Hg)
6-130112-00	Low Pressure Gauge (0-100 psi)*
6-130113-00	High Pressure Gauge (0-300 psi)*



### MASTER ALARM

1/4" or 1/8" NPT x DISS Gas Fitting with Check Valve (GAS SPECIFIC)

OXYGEN MA-102-101

MEDICAL AIR MA-112-111

NITROUS OXIDE MA-122-121

NITROGEN MA-142-142

CARBON DIOXIDE MA-182-181

INSTRUMENT AIR MA-162-161

VACUUM MA-132-131

WAGD MA-152-151

Sold as a 2 Piece Kit



**24 HOUR SERVICE**



YOUR JUST IN TIME RENTAL SUPPLIER

www.valuemed.co

888-998-8633

ValueMed.sales@gmail.com

# MEDICAL GRADE FITTINGS

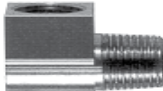
NPT FITTINGS 200 PSI MAX / TUBING NIPPLES							
HEX NIPPLE		CONNECTOR		COUPLER		90° STREET ELBOW	
							
PART#	DESCRIPTION	PART#	DESCRIPTION	PART#	DESCRIPTION	PART#	DESCRIPTION
MH18-18	1/8" M NPT x 1/8" M NPT	FC18-M18	1/8" F NPT x 1/8" M NPT	F18-F18	1/8" F NPT x 1/8" F NPT	FE18-M18	1/8" F NPT x 1/8" M NPT
MH14-14	1/4" M NPT x 1/4" M NPT	FC18-M14	1/8" F NPT x 1/4" M NPT	F14-F14	1/4" F NPT x 1/4" F NPT	FE14-M18	1/4" F NPT x 1/8" M NPT
MH18-14	1/8" M NPT x 1/4" M NPT	FC14-M18	1/4" F NPT x 1/8" M NPT	F14-F18	1/4" F NPT x 1/8" F NPT	FE14-M14	1/4" F NPT x 1/4" M NPT
		FC14-M14	1/4" F NPT x 1/4" M NPT				

90° ELBOW	
	
PART#	DESCRIPTION
18-ENPT	1/8" F NPT
14-ENPT	1/4" F NPT

WYE BLOCK	
	
PART#	DESCRIPTION
22-18-18	1/8" All Ports
22-18-14	1/8" Inlet, 1/4" Outlets

FEMALE TEE	
	
PART#	DESCRIPTION
T-18-18	1/8" F NPT
T-14-14	1/4" F NPT

POWER TAKE OFF	
	
PART#	DESCRIPTION
P-24	OXYGEN
P-16	MEDICAL AIR

1/4" ID FEMALE NPT TO HOSE BARB	
	
PART#	DESCRIPTION
F-18-77	1/8" NPT Female
F-14-77	1/4" NPT Female

1/4" ID MALE NPT TO HOSE BARB	
	
PART#	DESCRIPTION
M-18-77	1/8" NPT Male
M-14-77	1/4" NPT Male

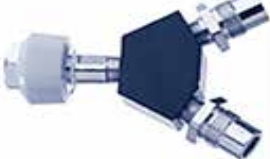
	
22-102-100	OXYGEN
22-112-110	AIR
22-132-130	VACUUM

YOKE TEE	
	
013-00	

SWIVEL STYLE TUBING NIPPLE		
		
132EMG	Green	100/Pkg
0137	Yellow	50/Pkg
0135	White	50/Pkg
0135BLU	Blue	50/Pkg
0132BKW	Black/White	50/Pkg
0132BLK	Black	50/Pkg
0138	Clear	50/Pkg

	
<p><b>EQUIPMENT REPAIR WHITE GLOVE SERVICE</b>            FILL THE BASKET WITH BROKEN EQUIPMENT, GIVE US A CALL - WE WILL PICK UP, REPAIR &amp; RETURN YOUR REPAIRS PROMPTLY  <b>888-998-8633</b></p>	



# MEDICAL GRADE FITTINGS

## DISS BODY ADAPTERS

DISS FEMALE HEX NUT BY NPT		
1/8" PART#	1/4" PART#	GAS
101-18	101-14	OXYGEN
111-18	111-14	AIR
121-18	121-14	NITROUS OXIDE
131-18	131-14	VACUUM
141-18	141-14	NITROGEN
191-18	181-14	CARBON DIOXIDE
161-18	161-14	INSTRUMENT AIR
151-18	151-14	EVAC



HEX NUT BY NPT

DISS FEMALE HAND TIGHT BY NPT		
1/8" PART#	1/4" PART#	GAS
100-18	100-14	OXYGEN
110-18	110-14	AIR
120-18	120-14	NITROUS OXIDE
130-18	130-14	VACUUM
140-18	140-14	NITROGEN
180-18	180-14	CARBON DIOXIDE
150-18	150-14	EVAC
160-18	160-14	INSTRUMENT AIR



HAND TIGHT BY NPT

DISS FEMALE HEX NUT BY 1/4" HOSE BARB	
PART#	GAS
101-77-14	OXYGEN
111-77-14	AIR
121-77-14	NITROUS OXIDE
131-77-14	VACUUM
141-77-14	NITROGEN
151-77-14	EVAC
181-77-14	CARBON DIOXIDE
198-77-14	HE-O2-1180 CGA, HELIUM UNDER 80%
161-77-14	INSTRUMENT AIR



HEX NUT BY 1/4" HOSE BARB

DISS FEMALE HAND TIGHT BY 1/4" HOSE BARB	
PART#	GAS
100-77-14	OXYGEN
110-77-14	AIR
120-77-14	NITROUS OXIDE
130-77-14	VACUUM
140-77-14	NITROGEN
150-77-14	EVAC
180-77-14	CARBON DIOXIDE
160-77-14	INSTRUMENT AIR



HAND TIGHT BY 1/4" HOSE BARB





**24 HOUR SERVICE**  
YOUR JUST IN TIME RENTAL SUPPLIER

www.valuemed.co  
888-998-8633  
ValueMed.sales@gmail.com

# MEDICAL GRADE FITTINGS

## DISS BODY ADAPTERS



### DISS MALE BY NPT MALE

1/8" PART#	1/4" PART#	GAS		
102-18	102-14	OXYGEN		
112-18	112-14	AIR		
122-18	122-14	NITROUS OXIDE		
132-18	132-14	VACUUM		
142-18	142-14	NITROGEN		
Not Available	152-14	EVAC		
Not Available	182-14	CARBON DIOXIDE		
Not Available	197-14	HE-O2-1180 CGA, HELIUM UNDER 80%		
162-18	162-14	INSTRUMENT AIR		

1/8" NPT MALE

1/4" NPT MALE

### DISS MALE BY NPT MALE WITH CHECK VALVE

1/8" PART#	1/4" PART#	GAS		
102-CV-18	102-CV-14	OXYGEN		
112-CV-18	112-CV-14	AIR		
122-CV-18	122-CV-14	NITROUS OXIDE		
Not Available	132-CV-14	VACUUM		
142-CV-18	142-CV-14	NITROGEN		
Not Available	152-CV-14	CARBON DIOXIDE		

1/8" NPT MALE

1/4" NPT MALE

### DISS MALE BY NPT FEMALE

1/8" PART#	1/4" PART#	GAS	
102-18F	102-14F	OXYGEN	
112-18F	112-14F	AIR	
122-18F	122-14F	NITROUS OXIDE	
132-18F	132-14F	VACUUM	
142-18F	142-14F	NITROGEN	

1/4" NPT FEMALE

### DISS MALE BY 1/4" HOSE BARB

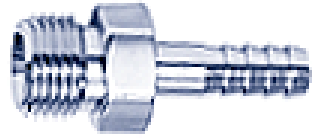
PART#	GAS	
102--77-14	OXYGEN	
110-77-14	AIR	
122-77-14	NITROUS OXIDE	
132-14F	VACUUM	
142-77-14	NITROGEN	

1/4" HOSE BARB

### DISS MALE BY DISS MALE

PART#	GAS	
102-102	OXYGEN 1240, 9/16	

DISS MALE BY DISS MALE





# MED GAS EXTENSIONS / HOSES

## RAIL AND WALL OUTLET EXTENSIONS



\* FAIRFIELD \* HOSPITAL SYSTEMS \* EASTERN \* HILL-ROM \*

<b>CHEMETRON</b>	<b>OXYGEN</b>
<b>OHMEDA</b>	<b>MEDICAL AIR</b>
<b>PURITAN BENNETT</b>	<b>VACUUM</b>
<b>MEDSTAR</b>	<b>NITROUS OXIDE</b>
<b>DISS</b>	

**CALL FOR DESIGN PLANS**  
\*ANY CONFIGURATION AVAILABLE\*



### CUSTOM WALL MOUNT EXTENSION MANIFOLDS

<b>CHEMETRON</b>	<b>OXYGEN</b>
<b>OHMEDA</b>	<b>MEDICAL AIR</b>
<b>PURITAN BENNETT</b>	<b>VACUUM</b>
<b>MEDSTAR</b>	<b>NITROUS OXIDE</b>
<b>DISS</b>	

**STANDARD 2 FOOT HOSE**  
\*CUSTOM LENGTHS AVAILABLE\*

### STANDARD 10 FOOT DISS FEMALE x DISS FEMALE HOSES

10 FT CONDUCTIVE FOR ANESTHESIA		
#100-10-22-100	Green	Oxygen
#110-10-23-110	Yellow	Air
#120-10-24-120	Blue	Nitrous Oxide
130-10-25-130	White	Vacuum
#140-10-26-140	Black	Nitrogen
150-10-27-150	Lavender	EVAC
180-10-28-180	Gray	Carbon Dioxide
10 FT NON CONDUCTIVE RESPIRATORY		
100-10-20-100	Green	Oxygen
110-10-21-110	Yellow	Air



**24 HOUR SERVICE**  
YOUR JUST IN TIME RENTAL SUPPLIER

www.valuemed.co  
888-998-8633  
ValueMed.sales@gmail.com

# SUCTION / SHUTDOWN EQUIPMENT

**\*\*MEDICAL GAS SHUTDOWN SERVICES\*\***

**\*\*LONG TERM & ON DEMAND RENTALS\*\***

**\*\*MEDICAL GAS TESTING AND CERTIFICATIONS\*\***

**\*\*SALES\*\*REPAIRS\*\***

**ASK ABOUT OUR PREMIER 24 / 7 SERVICES**

MOBLVAC 3			
	FOR USE WITH	PART NUMBER	DESCRIPTION
		Suction Pump	RW-067
<b>2 MODES AVAILABLE</b>			
<b>Continuous / Intermittent model:</b> up to <b>380mmHg &amp; 36lpm flow</b> (constant mode) <b>8 lpm</b> (intermittent mode)			
IDEAL FOR FLOOR UNITS AND ICU SUPPORT			
<b>Continuous only model:</b> up to <b>550 mmHg &amp; 38 lpm flow</b>			
IDEAL FOR SURGERY			

**AEROS INSTAVAC II**



The Instavac II is a high vacuum & high flow suction unit. It produces constant suction with vacuum & flow surpassing standard wall suction. Constant suction providing **550 mmHg** and over **38 lpm** flow.

**SSCOR DUET BATTERY OPERATED SUCTION PUMP**

**\*\*IDEAL FOR\*\***  
**\*\*CRASH CARTS\*\***



- An AC suction unit, with battery back up, the Duet provides instant, powerful suction whether or not AC power is available.
- When fully charged, the sealed lead acid battery provides **45 minutes** of suctioning power.
- Provides suction up to **525mmHg**



# SUCTION / SHUTDOWN EQUIPMENT

LET US HELP WITH YOUR **EMERGENCY** AND **PLANNED SHUTDOWNS**

\* PLANNING \* SETUP \* MONITORING \* REMOVAL \*

COMPLETE SUPPORT OF SHUTDOWN \* FULL SERVICE SHUTDOWN

## SHUTDOWN REGULATORS AND HOSES

AIR - OXYGEN - NITROUS OXIDE - NITROGEN

50 PSI PRESET REGULATORS

0-100 PSI ADJUSTABLE REGULATORS



## CYLINDER CARTS FOR GAS SHUTDOWNS

OVER 300 CYLINDER CARTS AVAILABLE IN VARIOUS TANK SIZES



## AIR COMPRESSORS

STANDARD COMPRESSOR

**TIMETER 3500**  
42 LPM FLOW  
50 PSI



HEAVY DUTY COMPRESSOR

**TIMETER 2000**  
56LPM FLOW  
50 PSI



IDEAL FOR USE WITH VENTILATORS



**24 HOUR SERVICE**  
YOUR JUST IN TIME RENTAL SUPPLIER

www.valuemed.co  
888-998-8633  
ValueMed.sales@gmail.com

# PIPELINE EQUIPMENT

## ZONE VALVE BOXES



Dew Point Readings  
Hydrocarbon Sampling  
Purity Sampling  
Trace Gas Sampling

## ALARM PANELS



GAS OUTLET STATIONS  
OUTLETS AND PARTS AVAILABLE



## ON SITE PURITY TESTING & RESULTS



ANNUAL TESTING  
AFTER RENOVATION  
TESTING INSTANT REPORTS  
TO ENSURE SAFETY

## MEDICAL GRADE BALL VALVES AND CHECK VALVES



BALL VALVES

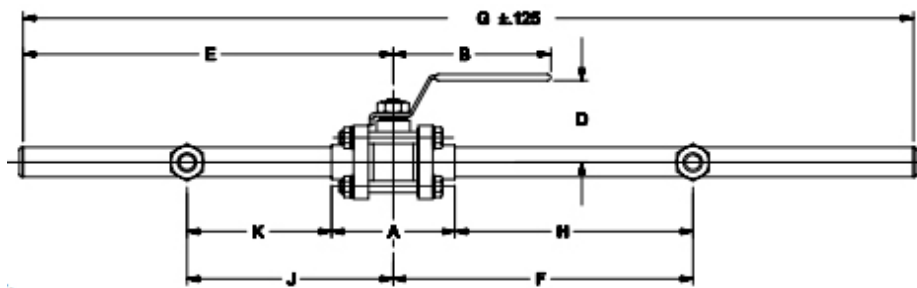

BALL VALVES

DIMENSIONS (Inches)

Valve Size	Part Number	A	B	D	E	F	G	H
1/2"	41050-01	2.62	3.35	1.69	7.87	6.37	21.00	5.06
3/4"	41075-01	2.93	4.33	1.89	8.25	6.06	21.00	4.60
1"	41100-01	3.44	4.33	2.05	8.58	5.87	21.00	4.15
1-1/4"	41125-01	3.96	5.12	2.56	8.75	5.50	21.00	3.52
1-1/2"	41150-01	4.43	5.12	2.72	8.87	5.37	21.00	3.16
2"	41200-01	5.55	6.30	3.15	10.87	5.00	21.00	2.23
2-1/2"	41250-01	6.73	9.06	4.29	16.00	4.25	32.00	0.89
3"	41300-01	7.56	9.06	4.61	16.00	4.50	32.00	0.72
4"	41400-01	9.80	11.73	7.90	16.00	7.90	32.00	3.00



CHECK VALVE SIZES

Check Valve Size	Part Number
3/4"	51075-01
1"	51100-01
1-1/4"	51125-01
1-1/2"	51150-01
2"	51200-01
2-1/2"	51250-01
3"	51300-01
4"	51400-01





# GAS CERTIFICATION



## GAS ANALYSIS & OUTLET VERIFICATION

**\*\*Member of the NFPA\*\***

NFPA 99 requires that after any renovation, modification or addition, a medical gas or vacuum system is to be inspected in accordance with the standards set by the NFPA.

**\*\*NFPA 99 & NFPA 55 REQUIRE ANNUAL OR SEMI-ANNUAL\*\***

**\*\*INSPECTIONS OF PATIENT CARE FACILITIES\*\***

<b>ValueMed Offers Many Different Testing Options</b>	
<b>Medical Gas Outlets - Function &amp; Operation</b>	
<ul style="list-style-type: none"> <li>*Oxygen</li> <li>*Medical Air</li> <li>*Nitrous Oxide</li> <li>*Nitrogen</li> <li>*Carbon Dioxide</li> <li>*Instrument Air</li> <li>*Vacuum</li> <li>*WAGD</li> </ul>	
<b>Zone Valves</b> Function & Operation	 <p><b>Current Code Book</b> <b>PART #</b> <b>NFPA-HCFC</b></p>
<b>Alarm Panels</b> Area and Master Function & Operation	
<b>Medical Gas Manifolds</b> Function & Operation	
<b>Medical Vacuum Pump</b> Function & Operation	
<b>Medical Gas Purity Analysis</b>	
<b>Dew Point Determination</b>	
<b>Trace Gas Analysis</b>	
<b>Lab Hoods</b> Function & Operation	
<b>Carbon Monoxide Safety Tests</b>	
<b>Methane Safety Tests</b>	
<b>Trace Hydrocarbons Safety Tests</b>	
<b>Employee Exposure Monitoring</b>	

<p><b><u>Full line of Shutdown Equipment</u></b> - Carts - Regulators - Suction Pumps - Oxygen - Air - Nitrous Oxide-</p>
<p><b>STATE OF THE ART EQUIPMENT &amp; QUALIFIED TECHNICIANS</b></p>
<p><b>MBIV</b></p> 
<p><b>*Reports Prepared Instantly*</b> <b>*Purity Results On Site*</b></p>



**24 HOUR SERVICE**  
YOUR JUST IN TIME RENTAL SUPPLIER

www.valuemed.co  
888-998-8633  
ValueMed.sales@gmail.com

# MRI EQUIPMENT

<b>NON FERROUS FLOWMETER</b>	
	
<b>.5 to 15 LPM</b>	
<b>18-NF</b>	

<b>MRI REGULATOR &amp; FLOWMETER</b>	
	
15-MRI-870-DI	E-YOKE
15-MRI-540-DI	H-NUT

<b>SINGLE CYLINDER WALL MOUNT - MRI</b>

<b>TW-E100A</b>

<b>CUSTOM MRI HOSES</b>

<b>BUILT TO YOUR NEEDS</b>

<b>MRI AIR OXYGEN BLENDER</b>	
	
BM-700-MRI-L	Low Flow
BM-700-MRI-H	High Flow

<b>MRI BLENDER POLE MOUNT CLAMP</b>

<b>BM-MRI-CLAMP</b>

<b>MRI LTV VENTILATOR POLE MOUNT CLAMP</b>

<b>VENT-LTV-CLAMP</b>

<b>MRI BED &amp; WHEEL CHAIR CYLINDER HOLDER</b>

<b>TW-EM-100A</b>

<b>4 HOOK MRI IV POLE</b>

<b>TW-S5110</b>

<b>MRI EQUIPMENT POLE</b>

<b>TW-D510</b>

<b>MRI DELUXE E-CYLINDER CART</b>	
	
TW-HC-100A MRI	SINGLE
TW-200A-MRI	DUAL

<b>MRI-CONDITIONAL SUCTION REGULATORS</b>

<b>CALL WITH ANY QUESTIONS</b>



# EQUIPMENT REPAIR SERVICES

## EQUIPMENT REPAIR WHITE GLOVE SERVICE



**FILL THE BASKET WITH BROKEN EQUIPMENT,  
GIVE US A CALL - WE WILL PICK UP,  
REPAIR & RETURN YOUR REPAIRS PROMPTLY**

### Airvo 2 Repair



### Blenders



### \*\*BLENDER OVERHAULS\*\*

#### OVERHAULS INCLUDE

- Ultrasonic Cleaning
- Replacement of Necessary Parts
- Testing \*\* Full PM Kit
- Calibration to Manufacturers Specs

**Bird  
BioMed Devices  
Tenacore  
Precision  
Sechrist**

**Overhauls are Recommended Every 2 Years**

### Flowmeters



### Wyes



### Regulators



### MR-850



### Med Gas Outlets



### Suction Regulators - Flat Rate Repair



### Respirometers



**24 HOUR SERVICE**  
YOUR JUST IN TIME RENTAL SUPPLIER

[www.valuemed.co](http://www.valuemed.co)  
888-998-8633  
[ValueMed.sales@gmail.com](mailto:ValueMed.sales@gmail.com)





# ValueMed

**YOUR JUST IN TIME SHUTDOWN SUPPLIER**

**LET US HELP WITH YOUR EMERGENCY AND PLANNED SHUTDOWNS**

\* PLANNING \* SETUP \* MONITORING \* REMOVAL

\* COMPLETE SUPPORT OF SHUTDOWN \* FULL SERVICE SHUTDOWN



**ValueMed**

**24 HOUR SERVICE**

*YOUR JUST IN TIME RENTAL SUPPLIER*

[www.valuemed.co](http://www.valuemed.co)

888-998-8633

[ValueMed.sales@gmail.com](mailto:ValueMed.sales@gmail.com)